

Stamped Glass Door Roller Assemblies

In Order by Wheel Diameter

27/32"

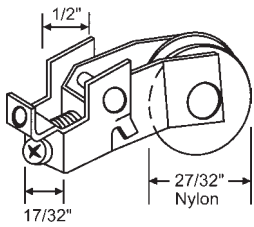

Part #	Wheel Type
9-291	Concave
9-291F	Flat

Used by Traco

7/8"

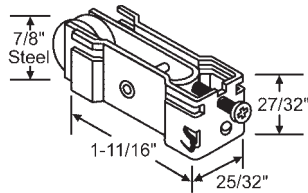

9-295

Acorn

1"

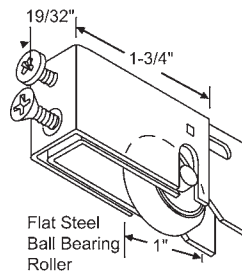

900-9469

Capitol/Remington

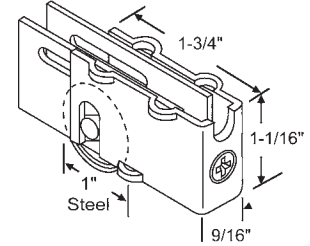

Part #	Wheel Type
9-305	Flat w/Tapered Edges
9-305SP	Concave

Capitol

1-1/16"

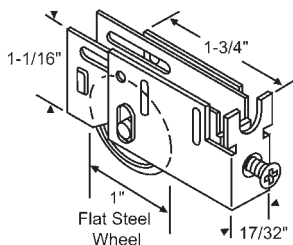

900-10138

Capitol/Remington

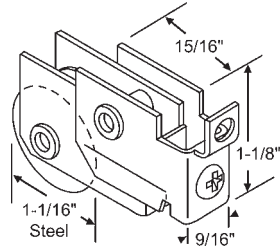

9-306

Capitol/Remington

1-1/8"

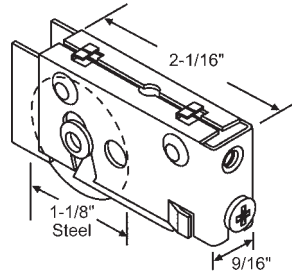

9-218

Max. Dimple Width 3/4"

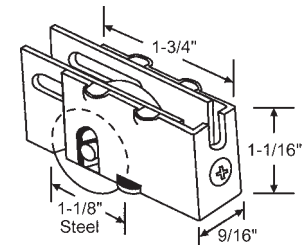

9-273

Remington

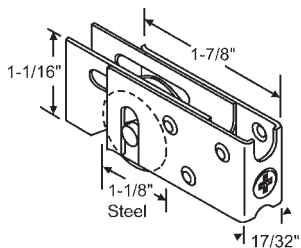

9-325

Max. Dimple Width 19/32"
No Longer Available. Use: 900-14295C

Metal Industries/Capitol

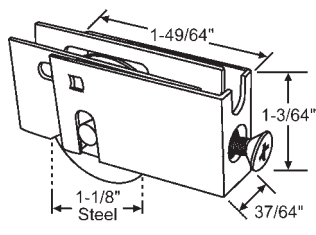

900-14295C

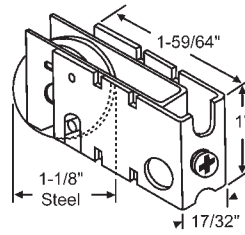

900-16711

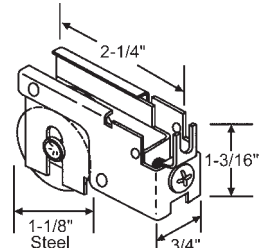

9-289

1-1/4"

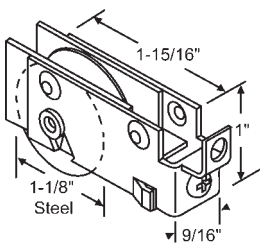

9-324

Max. Dimple Width 3/4"

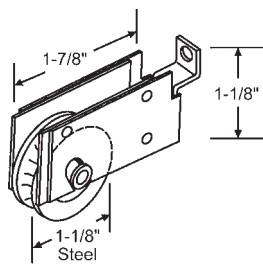

9-293

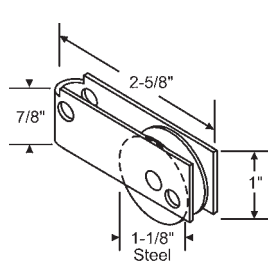

9-279

Top Hole
Capitol

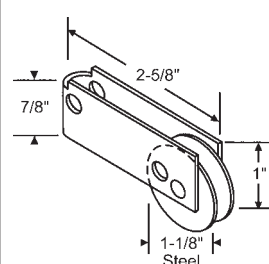

9-279-1

Bottom Hole
Capitol

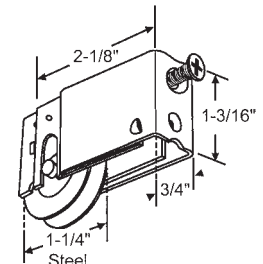

900-10106

Nu-Air

Stamped Glass Door Roller Assemblies

In Order by Wheel Diameter

1-1/4"

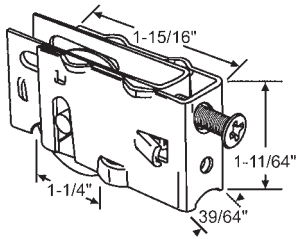

900-10095
Max. Dimple Width 13/16"
Betterbilt

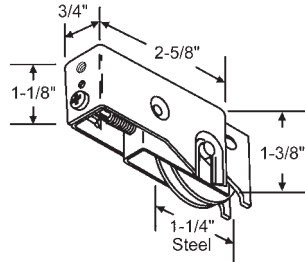

11-155
Axle Only

9-238

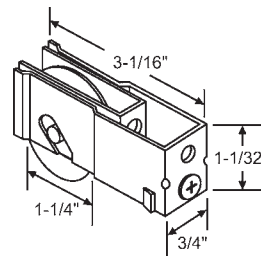

Part #	Wheel Type
9-258	Steel
9-258N	Nylon

Daryl

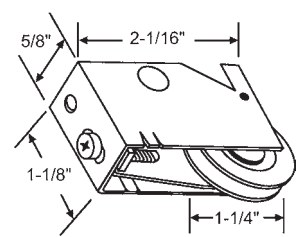

Part #	Wheel Type
9-245	Steel
9-245N	Nylon
9-245SS	Stainless Steel

Crossly

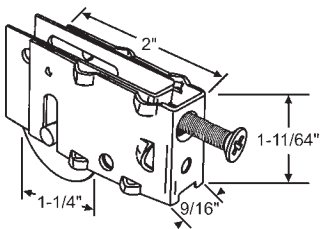

Part #	Wheel Type
900-7662	Steel
900-7662SS	Stainless Steel

Max. Dimple Width 3/4"

Acom

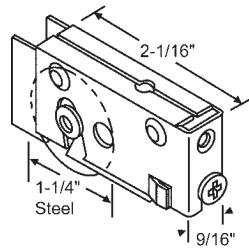

900-13579
Max. Dimple Width 23/32"

Arundel

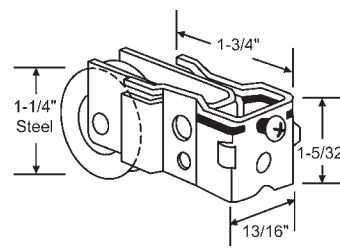

9-215

Acom

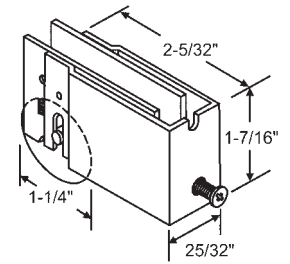

Part #	Wheel Type
9-331	Steel
9-331SS	Stainless Steel

Pennco

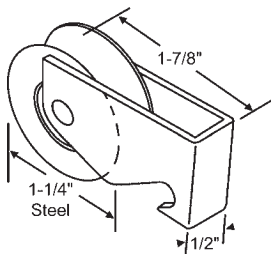

900-11663

Silverline

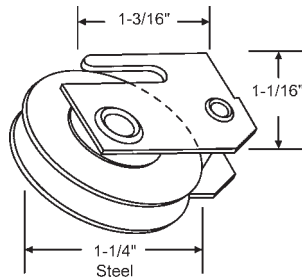

9-209

Ador Hi-Lite

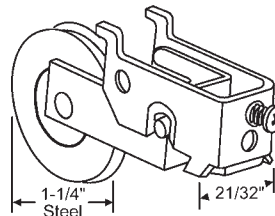

9-209A

Ador Hi-Lite

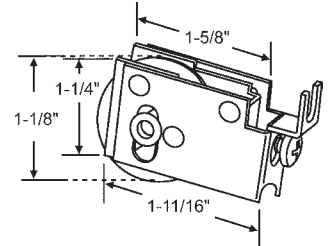

Part #	Wheel Type
900-13138	Steel
900-13138N	Nylon

Lock

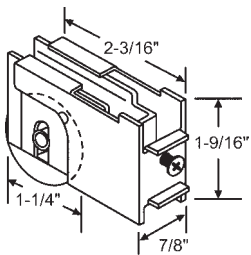

Part #	Wheel Type
9-266	Steel
9-266SS	Stainless Steel

Peachtree

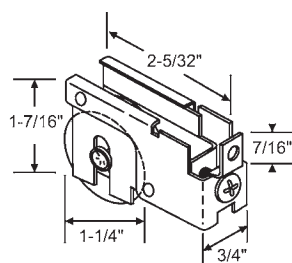

Part #	Wheel Type
9-200	Steel
9-200N	Nylon

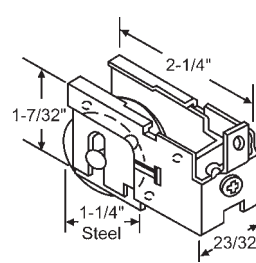

9-299

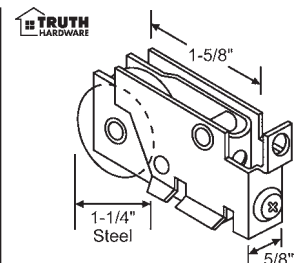

9-286

Stamped Glass Door Roller Assemblies

In Order by Wheel Diameter

1-1/4"

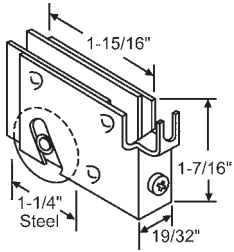

9-294

1-1/2"

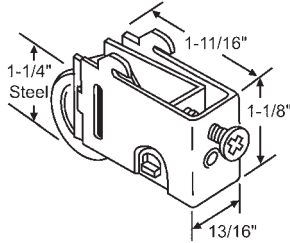

900-10098A

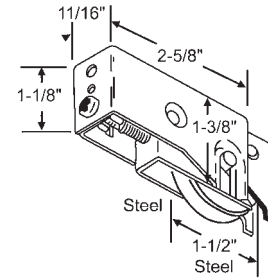

9-341

Lenahan/Daryl

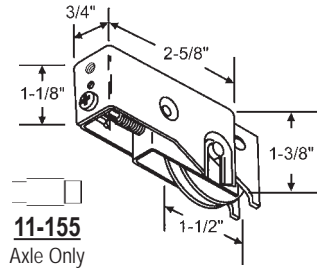

11-155
Axle Only

Part #	Wheel Type
9-261	Steel
9-261SS	Stainless Steel

Air Control/Keller

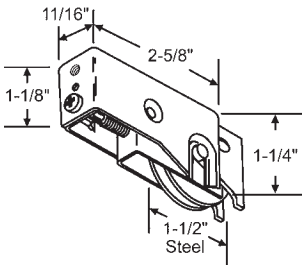

9-318

Jones

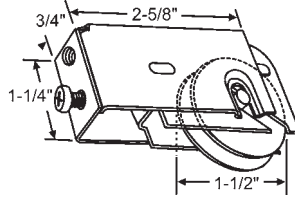

Part #	Wheel Type
9-392	Steel
9-392SS	Stainless Steel

Max. Housing Thickness 3/4"

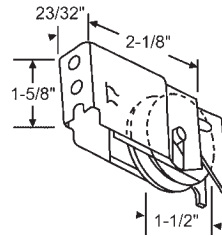

Part #	Wheel Type
9-304	Steel
9-304SS	Stainless Steel

Maximum Width at Locking Tangs 5/764"

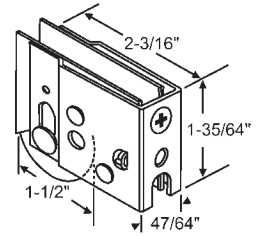

Part #	Wheel Type
900-11287	Steel

Maximum Width at Locking Tangs 7/8"
Crown/Lawson

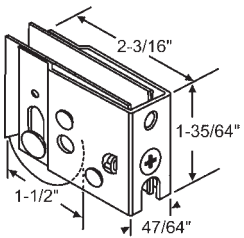

Part #	Wheel Type
9-338N	Nylon
9-338	Steel
9-338SS	Stainless Steel

Maximum Width at Locking Tangs 7/8"

Harcar

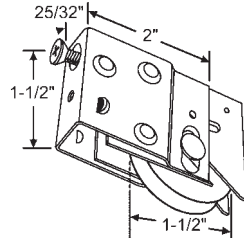

Part #	Wheel Type
9-366	Steel
9-366SS	Stainless Steel

Max. Dimple Width 29/32"
Max. Width at Locking Tangs 1"
Binnings/Pan Am

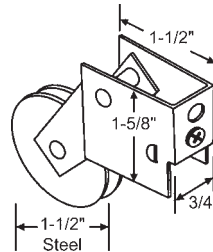

9-235

Keller

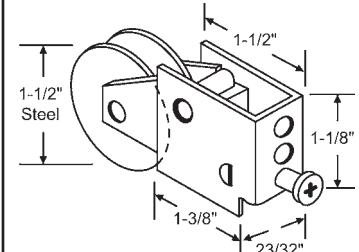

9-211

Harcar

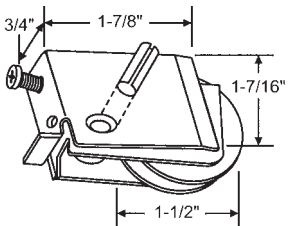

Part #	Wheel Type
9-255	Nylon
9-255M	Steel

Lumidor

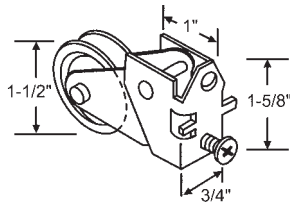

Part #	Wheel Type
9-233	Steel
9-233N	Nylon

Stanley

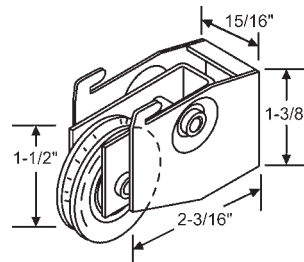

Part #	Wheel Type
9-220	Nylon
9-229	Steel

9-220

9-229

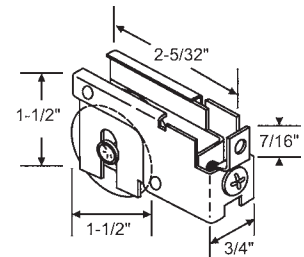

Part #	Wheel Type
9-201	Steel

9-201

Stamped Roller Assemblies

Die Cast Glass Door Roller Assemblies

In Order by Wheel Diameter

1-11/16"

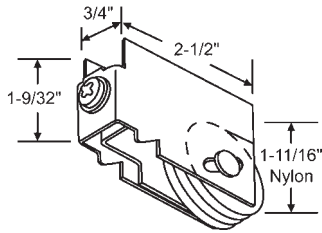

9-207N
Arcadia

7/8"

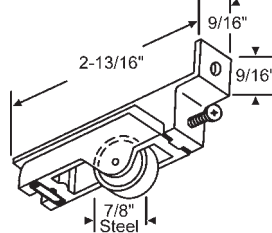

9-277
Atlas/Portalum

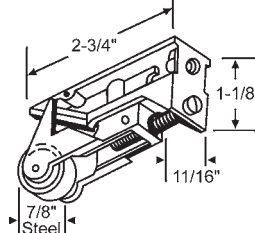

9-303
Flat Roller, Die Cast

1-1/4"

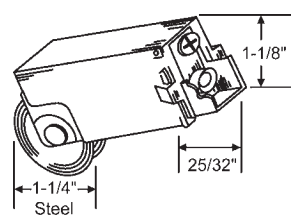

9-214
Binnings

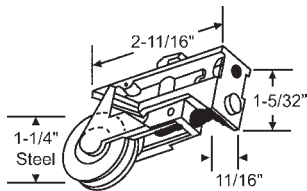

9-276

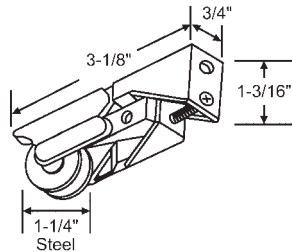

Part #	Wheel Type
9-248	Steel
9-248SS	Stainless Steel

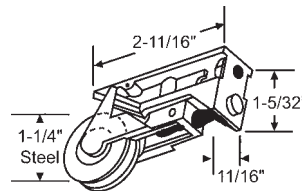

9-275

1-1/2"

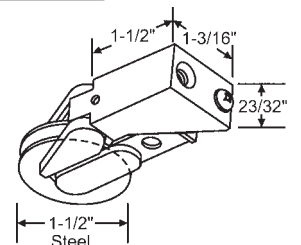

9-268
Die Cast
Keller/Air Control

Extruded Glass Door Roller Assemblies

1-1/4"

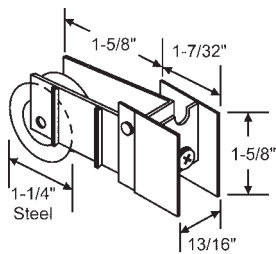

9-231
Peachtree

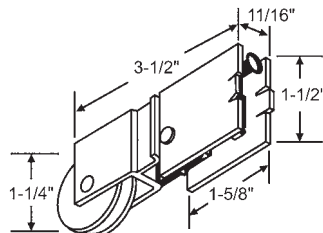

Part #	Wheel Type
9-205	Steel
9-205P	Nylon

Peachtree

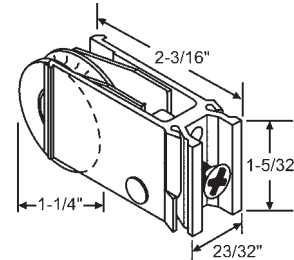

Part #	Wheel Type
9-252	Steel
9-252N	Nylon
9-252SS	Stainless Steel

Miller

1-5/16"

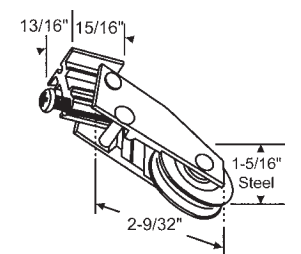

900-9582
Crossly

1-1/2"

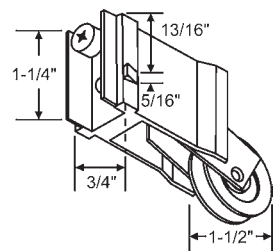

Part #	Wheel Type
9-247	Steel
9-247N	Nylon
9-247SS	Stainless Steel

Yale

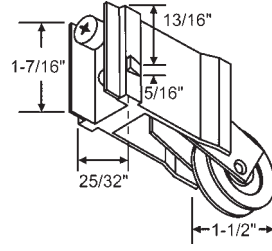

Part #	Wheel Type
9-237	Nylon
9-237S	Steel
9-237SS	Stainless Steel

Wallace

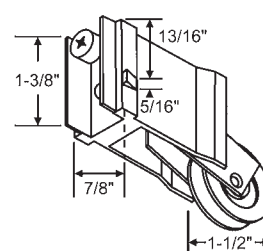

Part #	Wheel Type
9-257	Steel
9-257N	Nylon

Pan Am

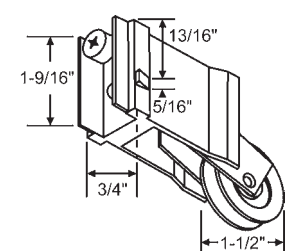

Part #	Wheel Type
9-249	Steel
9-249SS	Stainless Steel

Lawson

Extruded Roller Assemblies

In Order by Wheel Diameter

1-1/2"

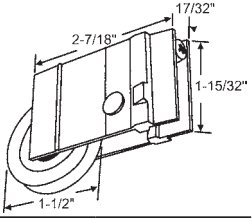

Part #	Wheel Type
9-364	Nylon
9-364S	Steel

Max. Width at Locking Tangs 31/32"
Lawson

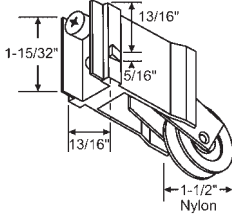

9-240
Plametrion

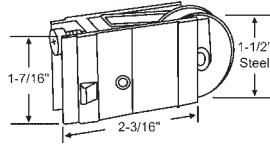

9-370
Wallace/Lawson

1-21/32"

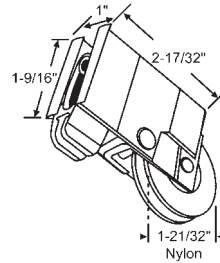

900-22583
Alcan/Norandex

1-11/16"

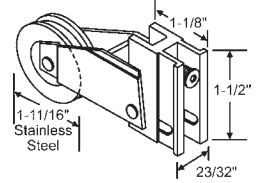

9-254SS
Daryl/Plaza

Tandem Rollers

In Order by Wheel Diameter

1"

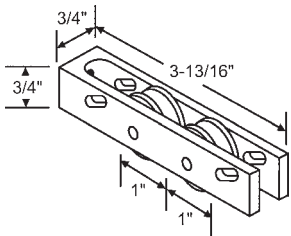

Part #	Wheel Type
9-267	Nylon
9-267S	Steel

1-1/8"

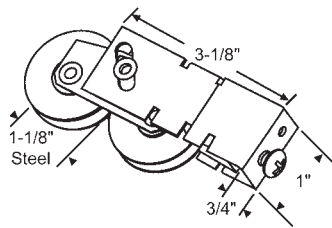

9-405A
Acorn

1-1/4"

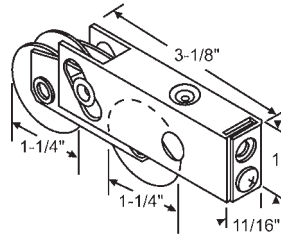

Part #	Wheel Type
900-19383	Steel
900-19383N	Nylon
900-19383SS	Stainless Steel

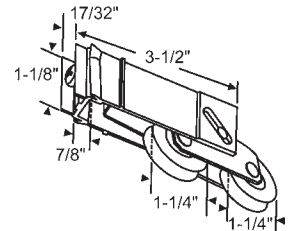

Max. Housing Width at Locking Tangs = 7/8"
Inner Housing Stainless Steel
Thermalume

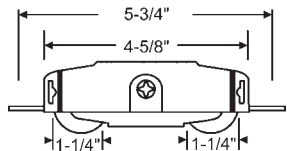

Part #	Wheel Type
9-239	Steel
9-312	Stainless Steel (Housing and Wheels)

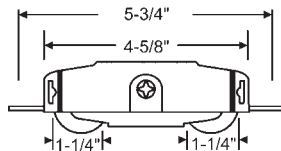

Part #	Wheel Type
9-239T	Steel
9-310T	Nylon
9-312T	Stainless Steel

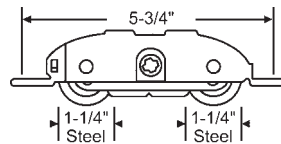

750-1273704

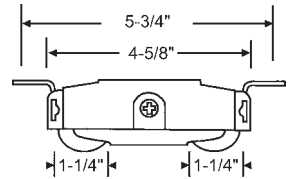

Part #	Wheel Type
9-313T	Steel
9-316T	Stainless Steel
9-346T	Nylon

1-1/2"

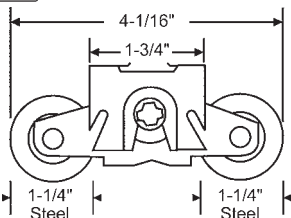

750-1997061

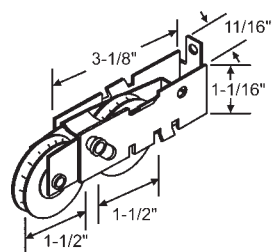

Part #	Wheel Type
9-234	Steel

Fleetwood

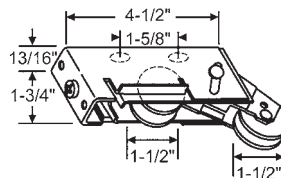

Part #	Wheel Type
9-280	Steel
9-280SS	Stainless Steel

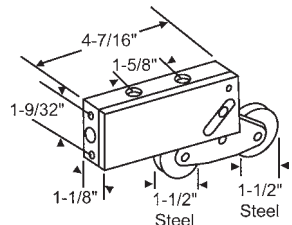

900-12198
Kawneer

Screen Door Roller Assemblies

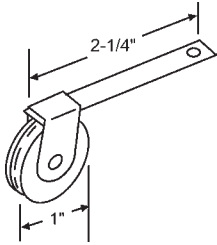

Part #	Wheel Type
10-356	Nylon
10-392	Steel

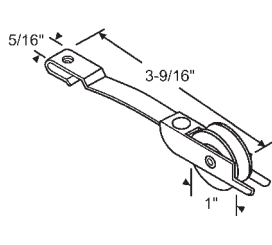

Part #	Wheel Type
10-407	Nylon
10-407M	Steel

Columbia

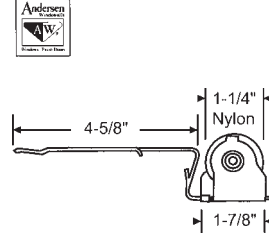

750-1997063
Upper

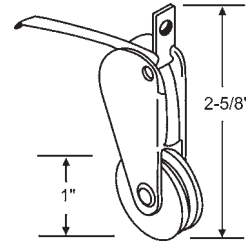

Part #	Wheel Type
10-312	Nylon
10-372	Steel

Metal Industries

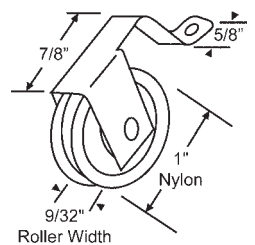

10-397

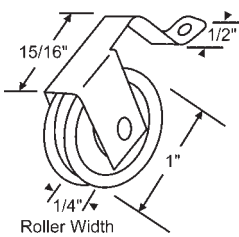

Part #	Wheel Type
10-396	Nylon
10-396M	Steel

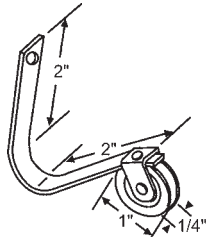

Part #	Wheel Type
10-359	Nylon
10-359M	Steel

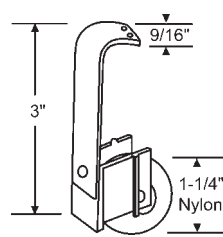

10-353

Peachtree

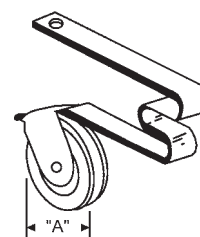

Part #	"A"	Wheel Type
10-358	7/8"	Nylon
10-314	1"	Nylon
10-371	1"	Steel

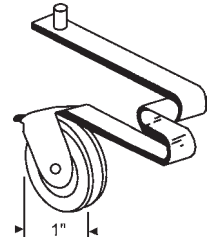

Part #	Wheel Type
10-306	Nylon
10-306M	Steel

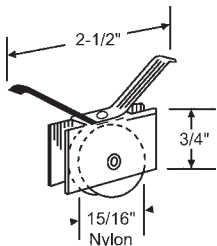

10-300
Keller

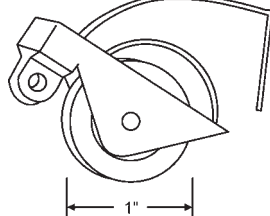

Part #	Wheel Type
10-348	Nylon
10-348M	Steel

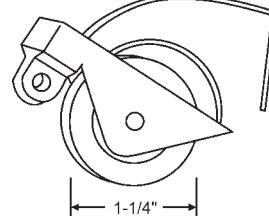

Part #	Wheel Type
10-360	Nylon
10-360M	Steel

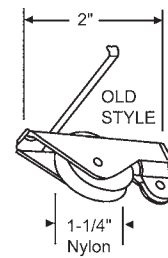

10-368

Acorn

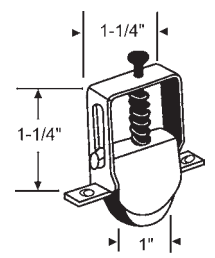

Part #	Wheel Type
10-343	Nylon
10-343M	Steel

Mounting Holes 1-11/16"

Columbia

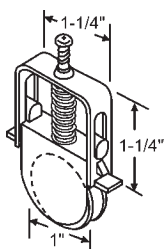

Part #	Wheel Type
10-403	Nylon
10-403M	Steel

Columbia

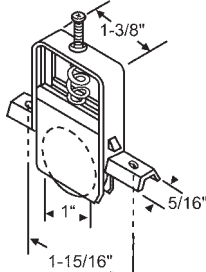

Part #	Wheel Type
10-406	Nylon
10-406M	Steel

Columbia

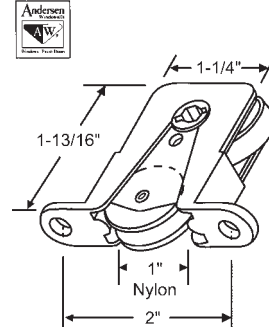

750-1274104

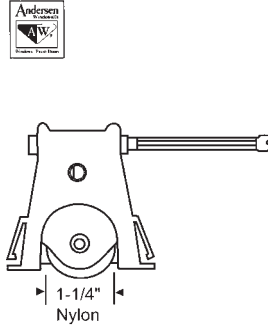

750-1997310
Lower

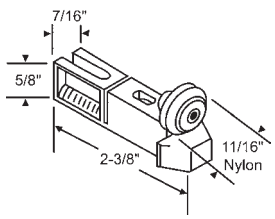

10-365

Ador Hi-Lite

Screen Door Roller Assemblies

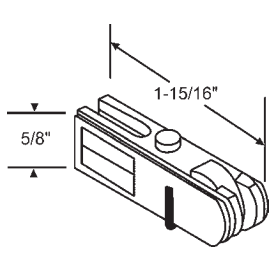

10-326

Ador Hi-Lite

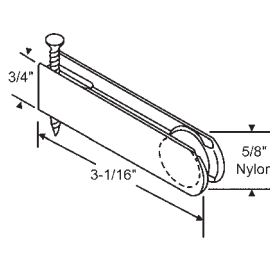

10-401

Weathershield

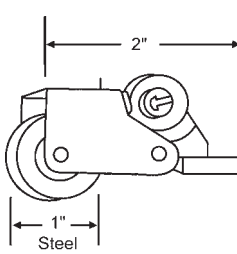

Part #	Hand
900-12879LH	LH (shown)
900-12879RH	RH

Adjustable Roller
Ritescreen

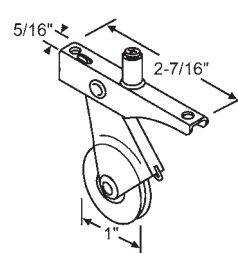

Part #	Wheel Type
10-410	Steel
10-410P	Nylon
10-410SS	Stainless Steel

Weather-Barr

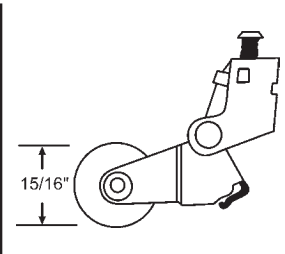

Part #	Wheel Type
10-367	Nylon
10-367M	Steel

Jim Walters

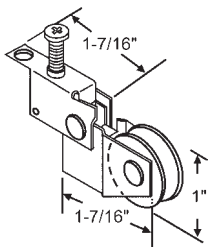

Part #	Wheel Type
900-19216	Nylon
900-19216M	Steel

Moss

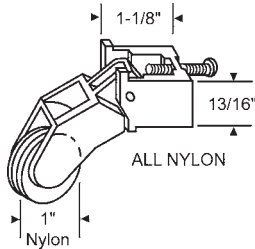

10-394

Peachtree

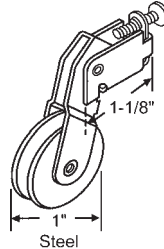

10-394M

Peachtree

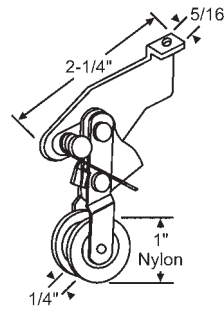

10-395

Use with 900-14766

Weather-Barr



900-17614
Adjustment Sleeve for 10-395



900-17615
Adjustment Screw for 10-395

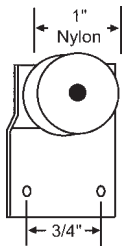

900-14766

Top Hung. Use with 10-395

Weather-Barr

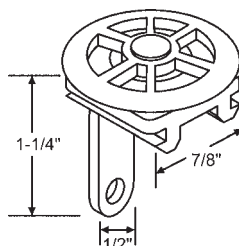

900-9068

Peachtree

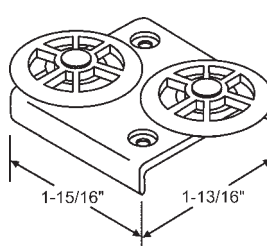

900-14226

Peachtree

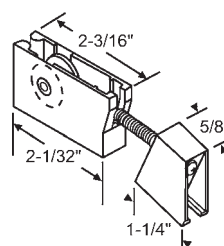

10-417

Old Style

Baltimore Thermal

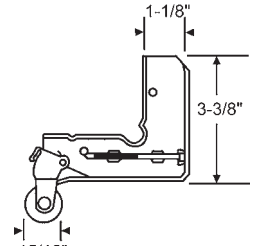

Part #	Wheel Type
10-373	Nylon
10-373M	Steel

Maximum Corner Thickness 7/16"

Jim Walters

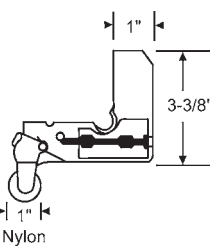

10-399

Maximum Corner Thickness
13/32"

Acorn

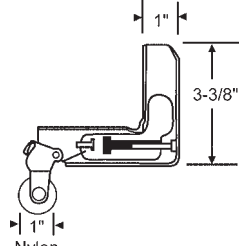

10-355

Maximum Corner Thickness
11/32"

Jim Walters

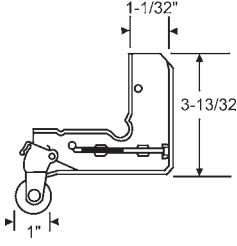

Part #	Wheel Type
10-398	Nylon
10-398S	Steel

Corner Thickness 7/16"
Used on Steel Framed Doors

Ritescreen

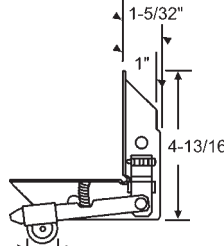

Part #	Hand
10-402LH	LH (shown)
10-402RH	RH

No Longer Available

Columbia

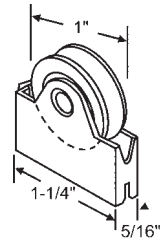

Part #	Wheel Type
10-408	Nylon
10-408M	Steel

Part of 10-402LH/RH

Columbia

Nylon Wheels

In Order by Wheel Diameter

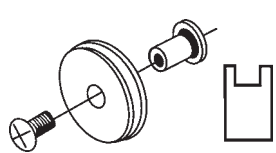
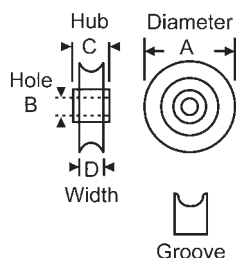

Part #	A	B	C	D
11-112	1-5/64"	1/4"	1/4"	15/64"

Nylon with Post and Screw
Air Control



Part #	A	B	C	D
11-120	1-1/4"	1/4"	11/32"	5/16"

Nylon with Ball Bearing Steel Hub

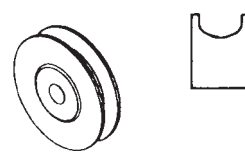

Part #	A	B	C	D
11-122	1-31/64"	1/4"	11/32"	19/64"

Nylon with Ball Bearing Steel Hub



Part #	A	B	C	D
11-110	1-11/16"	1/4"	29/64"	13/32"

Nylon with Steel Ball Bearing Hub

Steel Wheels

In Order by Wheel Diameter

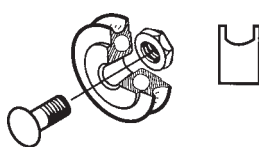

Part #	A	B	C	D
11-130	1"	1/4"	3/8"	5/16"

Steel with Steel Ball Bearing Hub,
Nut & Bolt. 11-130X for Roller Only

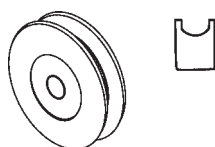

Part #	A	B	C	D
900-9576	1-1/8"	1/4"	3/8"	5/16"

Steel with Ball Bearing Hub

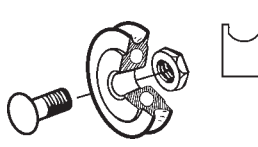

Part #	A	B	C	D
11-116	1-1/4"	1/4"	11/32"	5/16"

Steel with Steel Ball Bearing Hub
Nut & Bolt. 11-116X for Roller Only



Part #	A	B	C	D
11-139	1-1/4"	1/4"	51/64"	5/16"

Steel with Steel Ball Bearing Hub

Acorn



Part #	A	B	C	D
11-111	1-15/32"	1/4"	11/32"	5/16"

Steel with Steel Ball Bearing Hub

Part #	A	B	C	D
11-111SS	1-15/32"	1/4"	11/32"	5/16"

All Stainless Steel

Sliding Glass & Screen Door Keepers

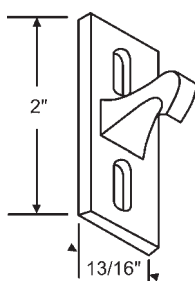

12-251
Chrome Plated
Miller

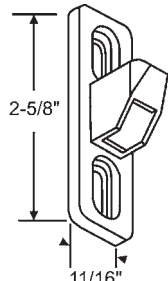

Part #	Finish
12-214	Chrome
12-214B	Black

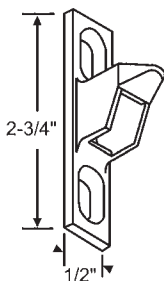

12-211
Chrome Plated
Narrow

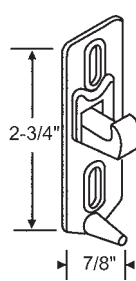

12-205
Chrome Plated
Crossly

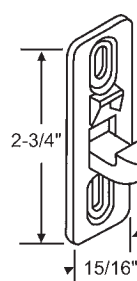

12-216

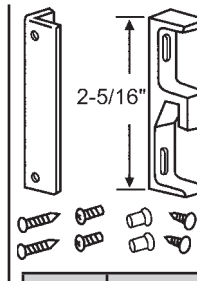

Part #	Finish
12-237	Aluminum
12-237B	Black

Universal Strike Kit

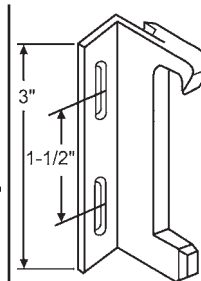

900-69
Mill Finish
Yale-Ogdon

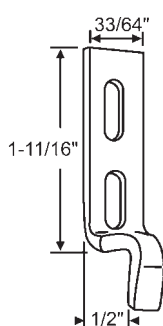

12-304
Metal
Wright Products

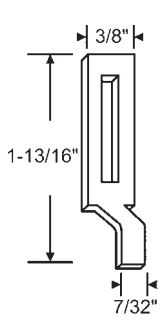

12-206
Metal
Rite Screen

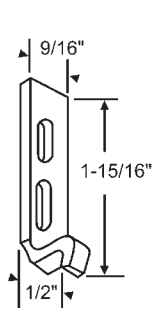

12-248
Metal
Acorn

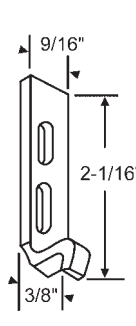

12-240
Steel
Wright Products



12-212
Mill Finish
Rite Screen

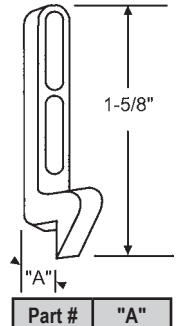

Part #	"A"
12-207	11/16"
12-226	3/16"
12-255	5/16"
12-230	15/32"

Mill Finish

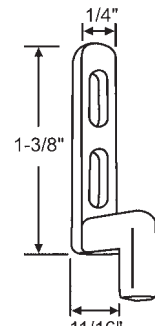

12-287
Bayform

Flush Mount Handles For Patio Doors

In Order by Hole Spacing

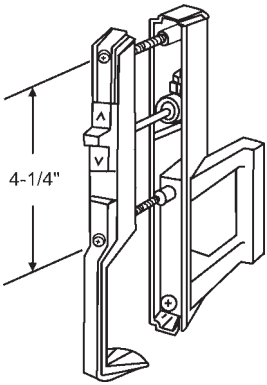

13-275

Black

Ariel- Peachtree

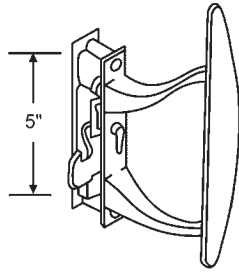

Part #	Hand	Finish
13-172	Shown	Aluminum
13-171	Opposite	Aluminum

Tucker

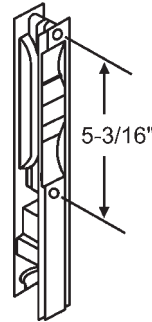

13-177

Daryl

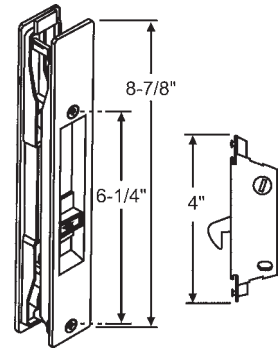

13-391

Adams Rite

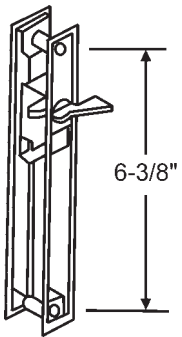

13-175

Less Key Lock

Miller

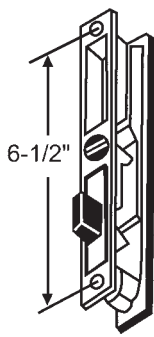

13-100

Handle Set Less Key Lock
Chrome Plated
For Optional Pull Handle Use 13-108

Crossly

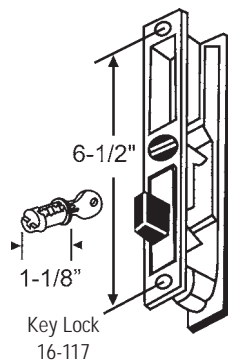

13-107

Handle Set with Key Lock
Chrome Plated
For Optional Pull Handle Use 13-108

Crossly

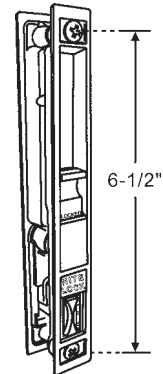

900-7559

Flush Mount Handle Set with Keeper and Nite Lock. Black

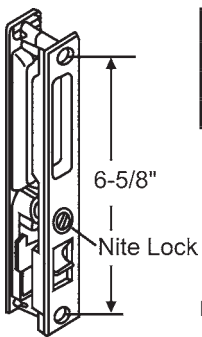

Fit-All Flush Mount Handle Set with Nite Lock

Handle Set without Key Cylinder

Part #	Finish
13-140	Chrome
13-140B	Black
13-140W	White

Handle Set with Key Cylinder

Part #	Finish
13-140K	Chrome
13-140BK	Black
13-140WK	White

Both Handle Sets Include: Each of 5 Cam Sizes (S,C,P,X,K), 2 Screws and Keeper

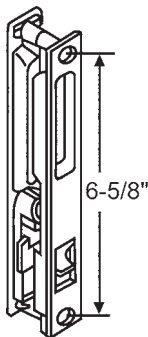

Fit-All Flush Mount Handle Set without Nite Lock

Handle Set without Key Cylinder

Part #	Finish
13-192	Chrome
13-192B	Black
13-192W	White

Handle Set with Key Cylinder

Part #	Finish
13-192K	Chrome
13-192BK	Black
13-192WK	White

Both Handle Sets Include: Each of 5 Cam Sizes (S,C,P,X,K), 2 Screws and Keeper

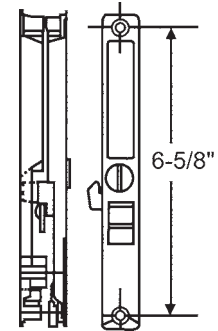

Part #	Finish
13-292	Chrome Plated
13-292W	White

With Nite Lock, "C" Cam and Keeper

Flush Mount Handles For Patio Doors

Handles For Patio Doors

In Order by Hole Spacing

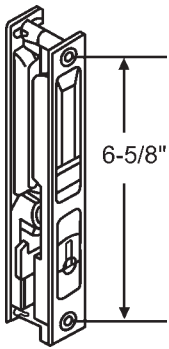

Part #	Finish
900-21019	Black
900-21019C	Chrome

With Nite Lock, "S" Cam and Keeper

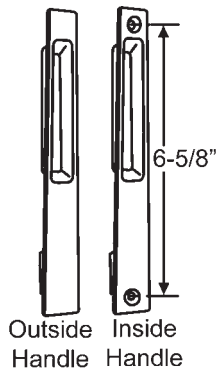

Outside Handle
Inside Handle

13-311

Flush mount dummy set.
Chrome

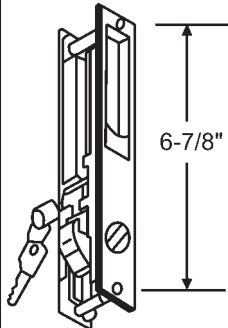

Part #	Description
13-178	w/Key Lock
13-178X	No Key Lock

Daryl

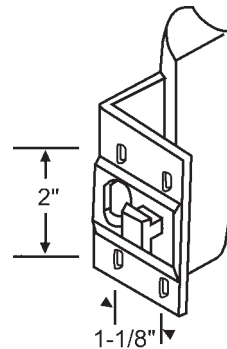

13-191

Used with Lock Bar 16-188 and 16-230

Capitol

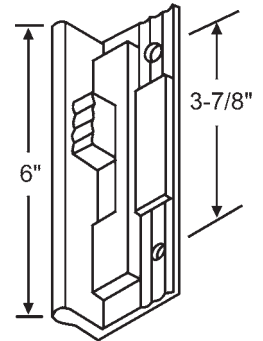

900-49

Interior Handle
Aluminum Finish

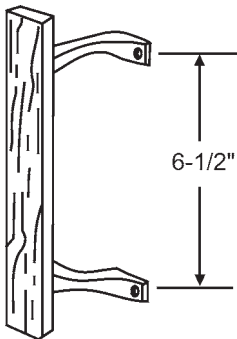

Part #	Finish
13-259	Chrome with Wood Handle
13-259B	Black with Wood Handle

Solid One Piece Bracket

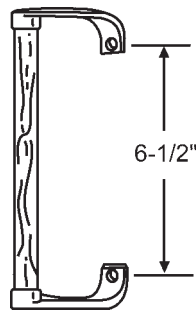

13-108

Wood with Chrome Brackets

Crossly

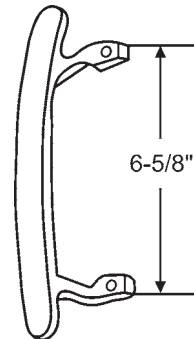

Part #	Finish
13-105	Chrome
13-105B	Black
13-105W	White

Die Cast

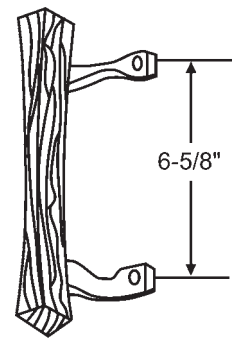

Part #	Finish
13-109	Chrome with Wood Handle
13-109B	Black with Wood Handle
13-109W	White with Wood Handle

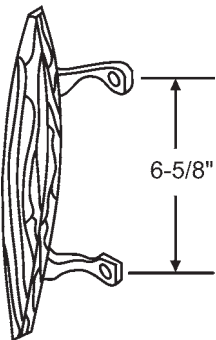

Part #	Finish
13-115	Chrome with Wood Handle
13-115B	Black with Wood Handle

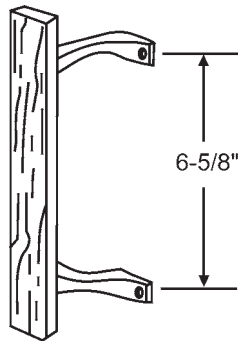

Part #	Finish
13-232	Chrome with Wood Handle
13-232B	Black with Wood Handle

Heavy Duty Brackets

Capitol

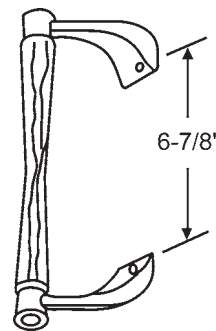

900-9

Walnut Handle with Brackets

Daryl

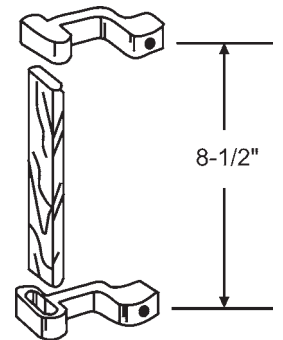

13-190B

Wood with Black Brackets

Use with 13-100 and 13-107

Capitol

Handle Brackets

Handle Sets For Patio Doors

In Order by Style and Hole Spacing

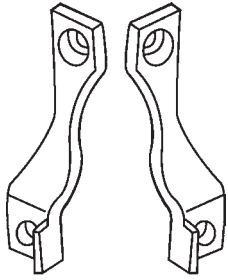

Part #	Finish
16-125	Black
16-123	Chrome

Handle Brackets Sold in Pairs
Used with 13-109, 13-115

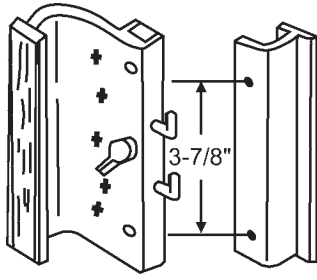

Part #	Finish
13-153	Aluminum
13-153B	Black

Ador Hi-Lite

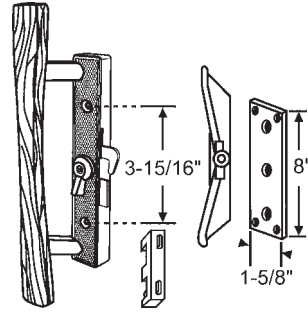

Handle Set with Plate

Part #	Finish
13-112	Aluminum with Wood Handle

Handle Set without Plate

Part #	Finish
13-112X	Aluminum with Wood Handle

Handle Set with Plate and 16-126 Key

Part #	Finish
13-113	Aluminum with Wood Handle

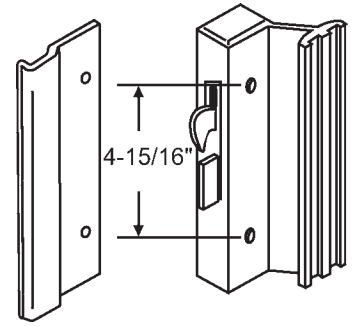

Part #	Finish
13-152	Aluminum
13-152B	Black

Includes Fit-All Keeper Assy., Screws and
Black Outside Pull

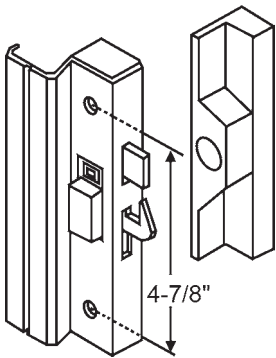

13-255
Black
Peachtree

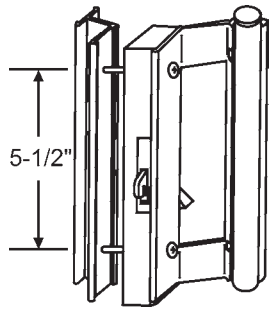

13-160
New Style
Aluminum Finish
Peachtree

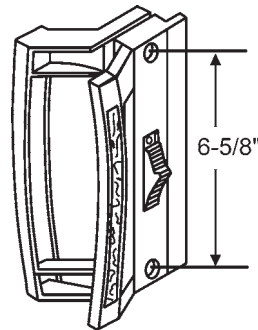

900-16317
Black. Includes Keeper and Screws
Norandex

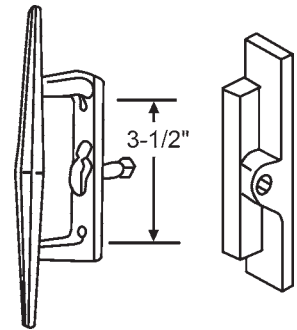

13-106
Original Acorn Metal Handle Set
Base Plate Only: 900-8200
Acorn

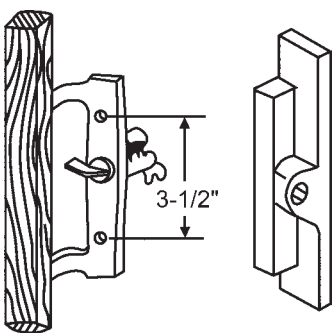

900-8388
Original Acorn Mahogany Handle-Also
Includes Bumpers, Stops, Keeper
and Screws.
Acorn

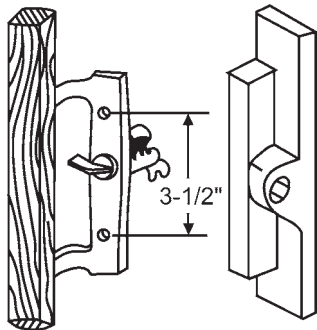

Handle Set without Key Cylinder

Part #	Finish
13-106X	Black

Handle Set with Key Cylinder

Part #	Finish
13-106KX	Black

Acorn Replacement

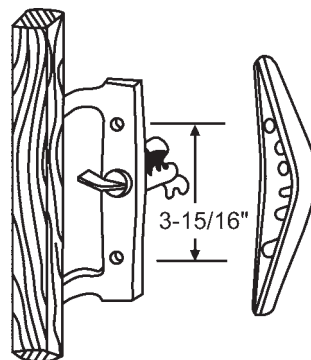

Part #	Finish	Description
13-104	Aluminum	No Key
13-104K	Aluminum	w/Key
13-141	Black	No Key

with 12-240 Keeper

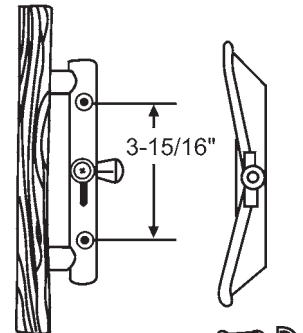

16-126
Key Lock

Handle Set with Key Lock

Part #	Finish
13-101	Aluminum w/Brown Handle

Handle Set without Key Lock

Part #	Finish
13-114	Aluminum w/Brown Handle

Handle Sets For Patio Doors

In Order by Style and Hole Spacing

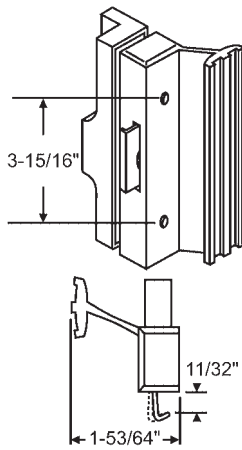

900-19556

Aluminum with Black outside pull
Pennco

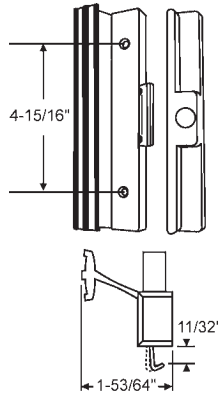

Part #	Handle Finish	Pull Finish
13-195	Black	Black
13-195A	Aluminum	Black
13-195W	White	White

Plastic Outside Pull
Better Bilt/Traco

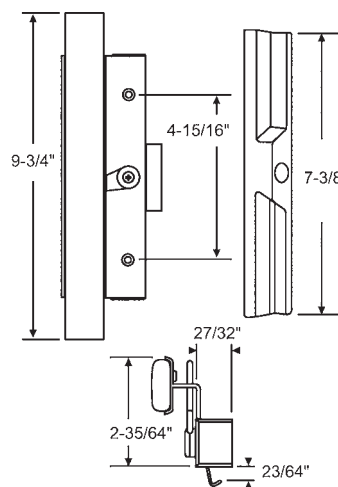

13-258

Black Finish. All Metal with Wood Handle
Rollyson

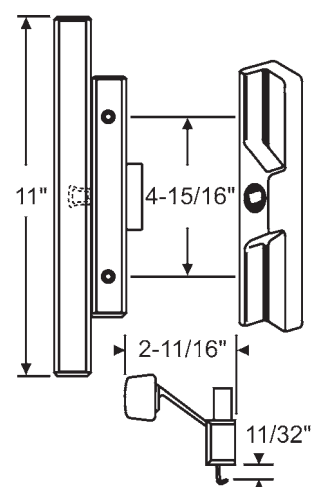

900-11414

Black with Wood Handle. Black Outside Pull
Traco

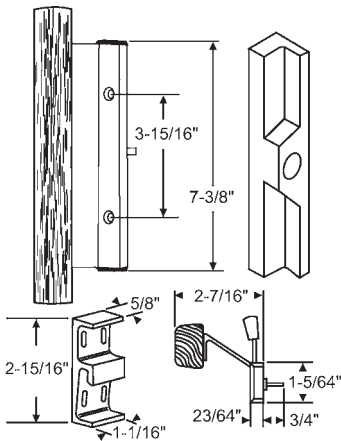

13-282BG

Beige. With 11" Solid Oak Bar and Keeper
Malta

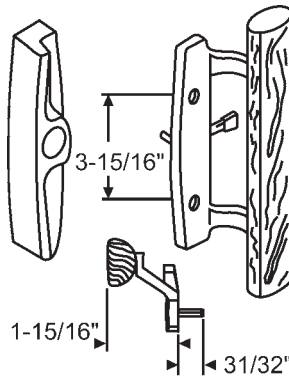

Handle Set without Key Cylinder

Part #	Finish
13-154	Black
13-154W	White
13-154CBZ	Bronze
13-154A	Almond

Handle Set with Key Cylinder

Part #	Finish
13-154K	Black
13-154WK	White

Metal with Wood Handle
Sash Controls

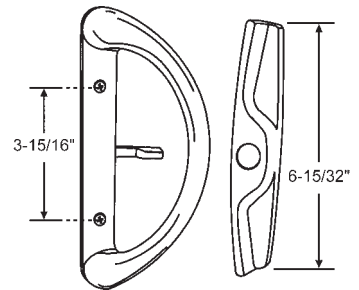

13-328-82

White .750 Lever w/ Screws

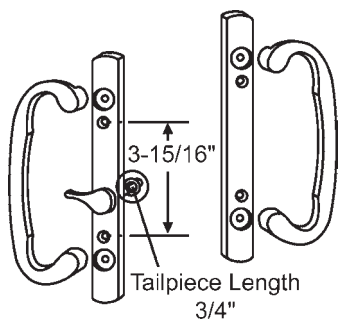

Part #	Finish
13-245BP	Brass Plated
13-245BC	Brushed Chrome
13-245W	White
13-245BZ	Bronze
13-245AB	Antique Brass

Offset Latch. 2265 Stamped on Back of Plate
Sash Controls

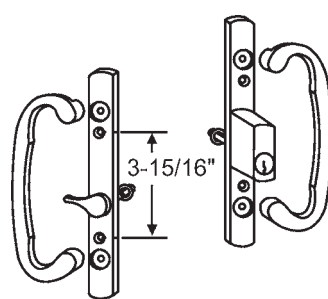

Part #	Finish
13-245WK	White
13-245BPK	Brass Plated
13-245BZK	Bronze
13-245ABK	Antique Brass

Offset Latch. 2265 Stamped on Back of Plate
Sash Controls

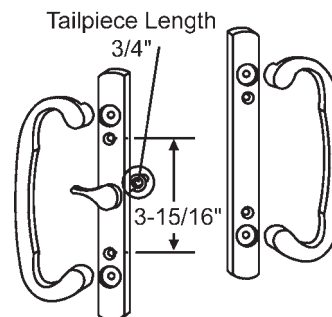

13-291

White. No Key. Center Latch
2265 Stamped on Back of Plate
Sash Controls

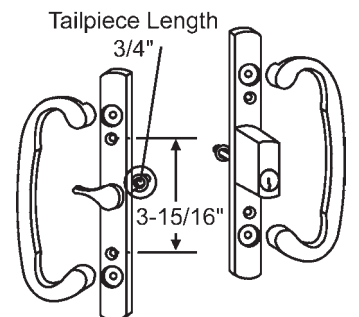

13-291K

White. With Key. Center Latch
2265 Stamped on Back of Plate
Sash Controls

Handle Sets For Patio Doors

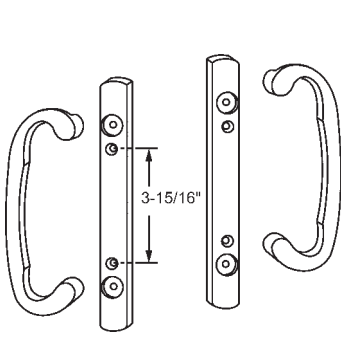

Part #	Finish
13-284DAB	Zinc-Antique Brass
13-284DBC	Zinc-Brushed Chrome

Dummy Set
Sash Controls

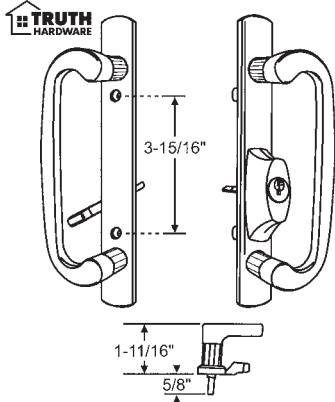

Part #	Description
13-295-10K	Offset Latch w/Key Lock
13-295-10D	Dummy Set

Black

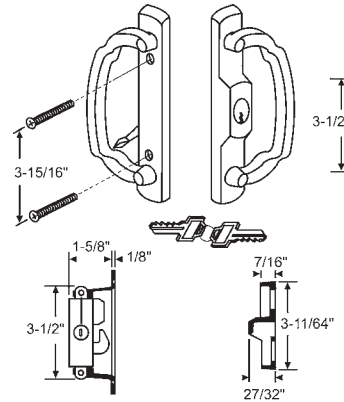

13-296PB

Solid Brass. Polished Brass finish with key combination mortise lock, keeper and all necessary screws.

Peachtree/Prado

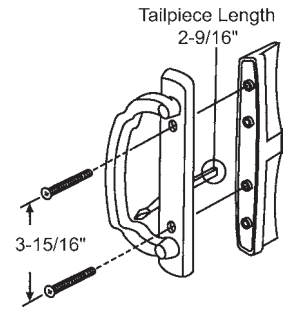

13-280
White
Acorn

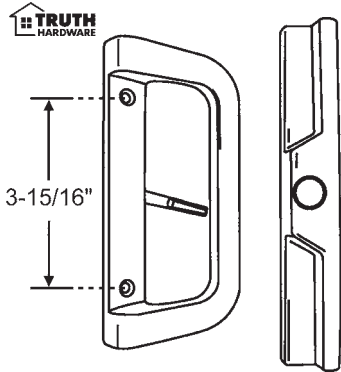

13-394-3
White

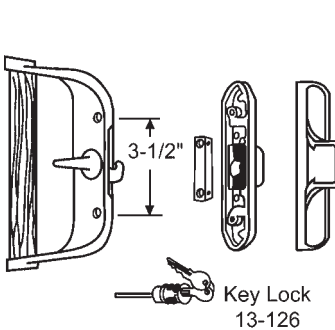

Part #	Description
13-188K	w/Key Lock
13-188	No Key Lock

Gray

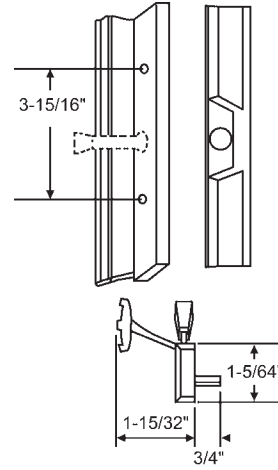

900-21409W
White

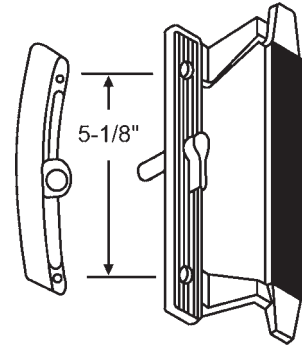

13-173
Gray Finish
13-194 Outside Pull Only
Howard

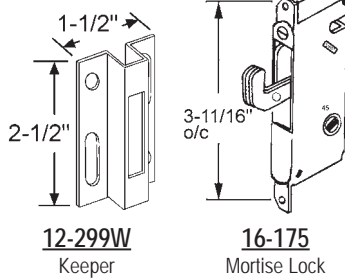
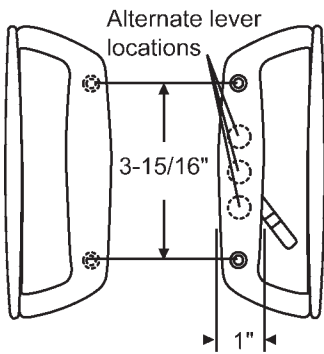

12-299W
Keeper

16-175
Mortise Lock

900-21630

White. Order Keeper and Mortise Lock Separately
American Weatherseal

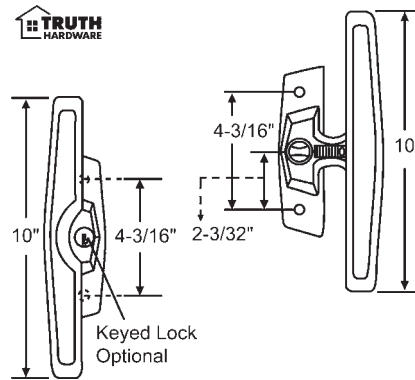

16-133
Key Cylinder
with Keys

Handle Set with Key Cylinder

Part #	Finish
13-202-1A	Bronze

Handle Set without Key Cylinder

Part #	Finish
13-203-1A	Bronze

Inside Handle

Part #	Finish
13-201-1	Bronze

Outside Handle with Lock
Cylinder Hole

Part #	Finish
13-202-1	Bronze

Outside Handle without Lock
Cylinder Hole

Part #	Finish
13-203-1	Bronze

Handle Sets For Patio Doors

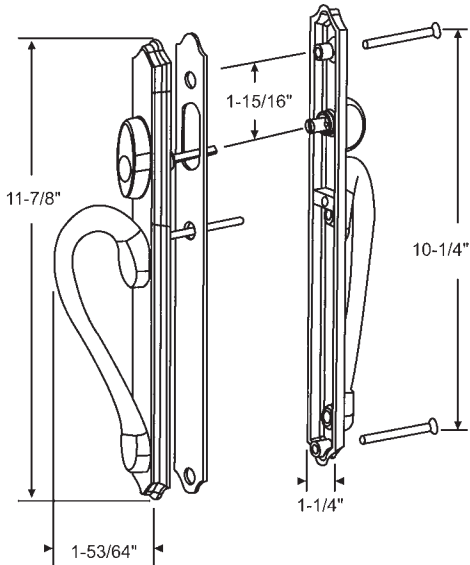

SOLID BRASS SLIDING DOOR TRIM SETS Active - Thumb Turn w/Key

For 2.0" Door	
Part #	Finish
13-345ORBZ	Oil Rubbed Bronze
13-345P	Pewter
13-345PB	Polished Brass

ZINC DIE CAST SLIDING DOOR TRIM SETS Active - Thumb Turn w/Key

For 1.7" Door	
Part #	Finish
13-346AD	Almond
13-346B	Black
13-346W	White

Active(Shown) - Thumb Turn No Key

For 1.7" Door	
Part #	Finish
13-347AD	Almond
13-347B	Black
13-347W	White

Passive - No Thumb Turn, No Key

For 1.7" Door	
Part #	Finish
13-348AD	Almond
13-348B	Black
13-348W	White

Note: Other Finishes Available for all
Trimsets
Ashland

Outside Handle Pulls For Patio Doors

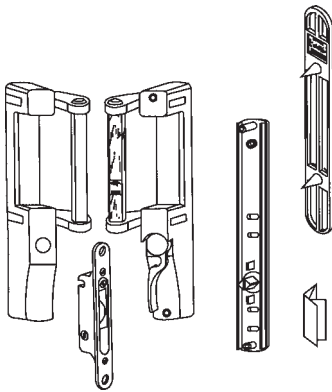

Part #	Finish
13-307PB	Polished Brass
13-307AB	Antique Brass

Hurd/Chatel

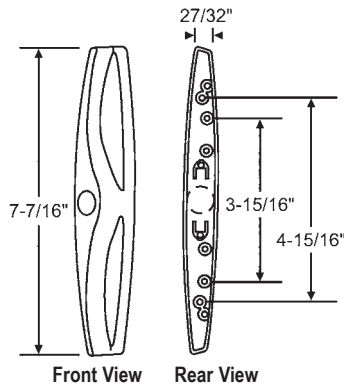

Part #	Finish
13-427B	Black
13-427W	White

Die Cast. No Cylinder Hole

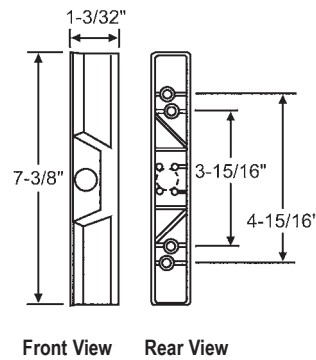

Part #	Description
900-8281	Black Plastic
900-8281M	Black Metal
900-8281MW	White Metal

Without Cylinder hole

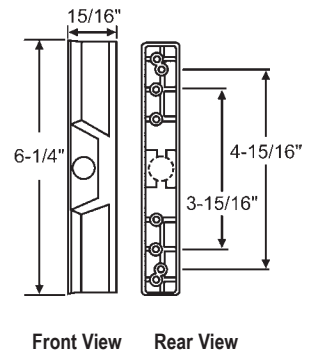

Front View Rear View

900-17370

Black

Without Cylinder Hole

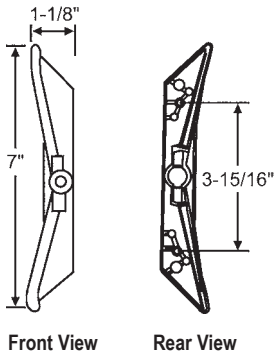

Front View Rear View

900-48

Aluminum
Die Cast

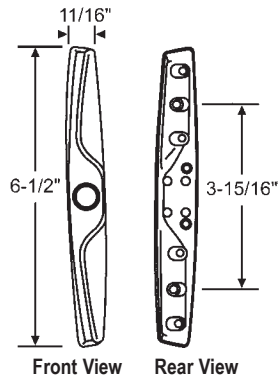

Part #	Finish
13-142	Aluminum
13-143	Black

Die Cast

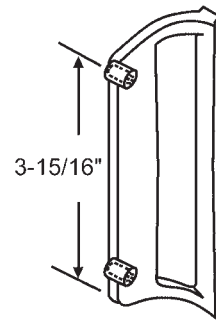

13-147

Flush Mount Pull. Aluminum

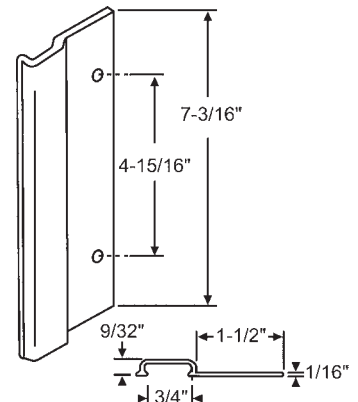

Part #	Finish
16-198	Aluminum
16-199	Black

Outside Pull

Handles For Patio Screen Doors

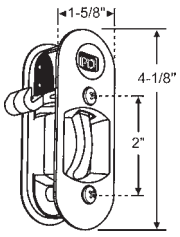

14-116
Almond
Peachtree

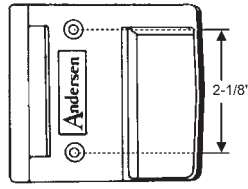

Part #	Finish
750-1997194	Stone
750-1997306	White

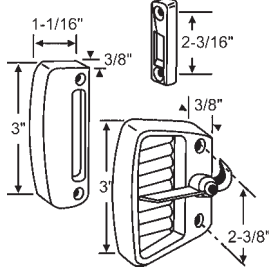

14-75B
Handle Assembly (3 pieces).
Black
Traco

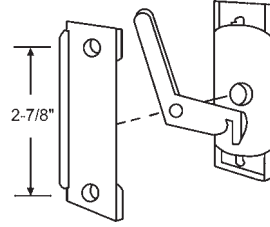

14-61
Handle Assembly with Latch
Walters

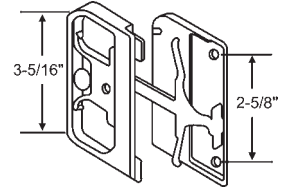

14-64
Metal Industries

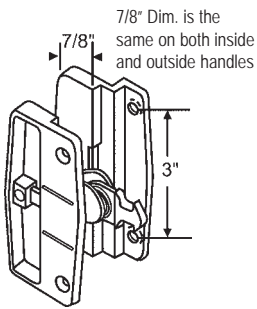

14-95
Handle Assembly
Columbia

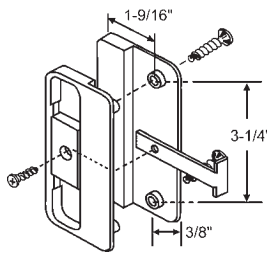

14-96
Handle Set. Black
Jim Walters

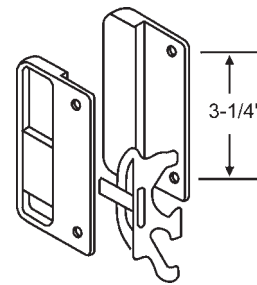

14-63
Handle Assembly
Jim Walters

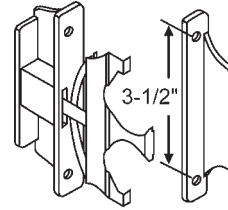

14-103
Black

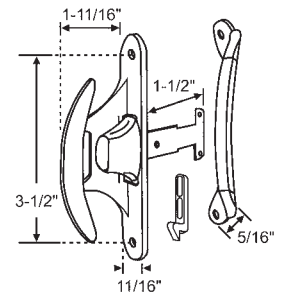

14-155A
Includes Keeper
Bayform

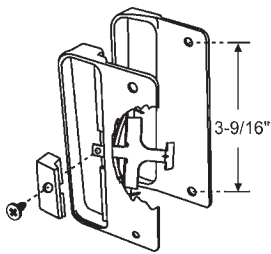

14-62
Acorn

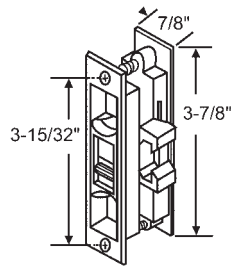

900-11214
Patio Screen Latch Assembly
Includes 12-308 Keeper
Peachtree

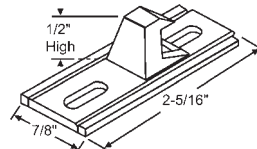

12-308
Black Plastic
Peachtree

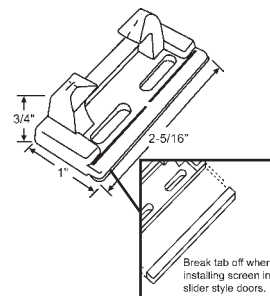

900-21646
Beige
Peachtree

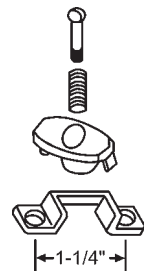

14-51
Latch Assembly
Acorn

Screen Door Guides

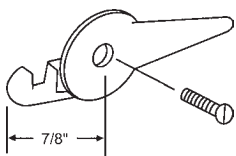

14-54S
Latch Assembly with Spring

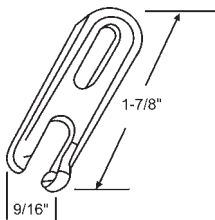

15-55
Screen Guide
Crossly

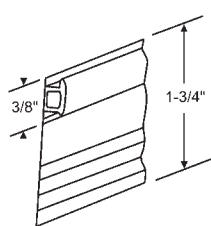

Part #	Length
16-243	50 ft.
16-243M	250 ft.

Can Be Torn Away in 3/16" Increments. Black

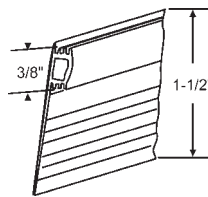

Part #	Length
16-244	50 ft.
16-244M	250 ft.

Can Be Torn Away in 1/8" Increments

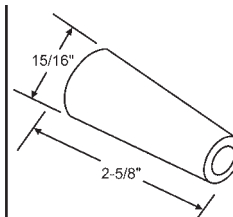

Part #	Finish
16-227B	Black
16-227W	White

Rubber

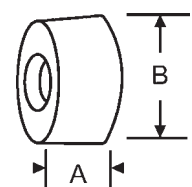

Part #	A	B	Finish
16-105	3/8"	15/16"	Gray
16-107	7/32"	3/4"	Clear

Rubber

Security Hardware & Patio Door Locks

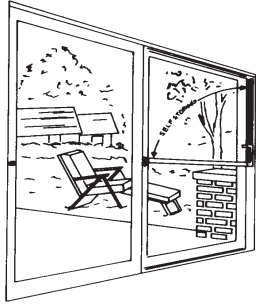

Makes Sliding Glass
Doors Jimmy-Proof!

**NEW STEEL
SAFETY KEY
LOCK**

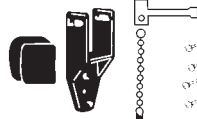

16-108H

Charley Bar Hardware Pack includes plastic saddle, rubber cap, four #8 1/2" sheet metal screws and metal angle bracket

**Mailing TUBE - 50 per carton
sold in carton qty only**

Part #	Size	Finish
16-108T	48"	Mill
16-108TB	48"	Bronze
16-108TW	48"	White

**Carded - 10 per carton
sold in carton qty only**

Part #	Size	Finish
16-108C	48"	Mill
16-108CB	48"	Bronze
16-108CW	48"	White

BULK - 25 per carton

Part #	Size	Finish
16-108	48"	Mill
16-108B	48"	Bronze
16-108W	48"	White
16-108-60	60"	Mill

Poly Bagged - 50 per Box

Part #	Size	Finish
16-108P	48"	Mill

- Key hangs neatly out of your way when not in use
- Comes with all necessary hardware and instructions
- Available in three lengths, three finishes and three packages
- Anodized Aluminum construction allows it to be cut to fit any size door
- New security feature: Improved black plastic saddle now takes a key so that the bar cannot be raised from the outside by wires or other devices
- New saddle keeps small children from opening the door from the inside

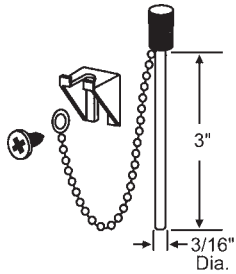

16-104

Burglar Pin/Nite Lock

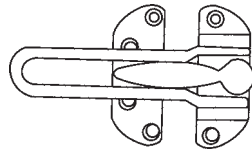

Part #	Finish
16-225C	Chrome
16-225PB	Brass

Door Guard

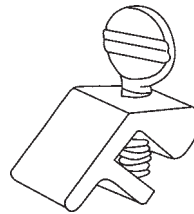

50-682

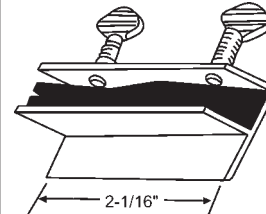

50-636

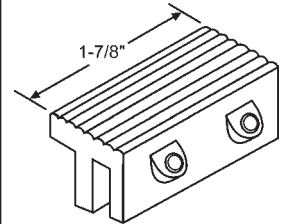

Part #	Finish
900-17508	Black
900-17508A	Aluminum

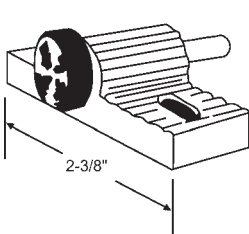

Part #	Finish
16-177	Aluminum
16-177B	Black

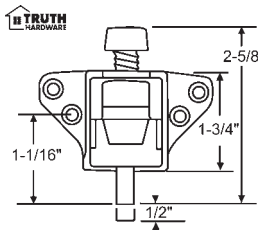

Part #	Finish
16-209-1	Bronze
16-209-3	White

Secondary Patio Lock

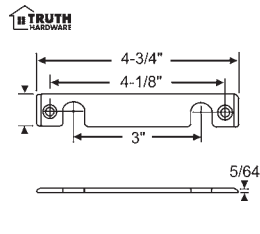

Part #	Finish
12-264-1	Bronze
12-264-3	White

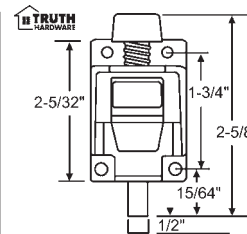

Part #	Finish
16-211-1	Bronze
16-211-3	White

Wingless Patio Lock

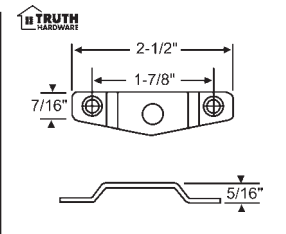

Part #	Finish
12-265-1	Bronze
12-265-3	White

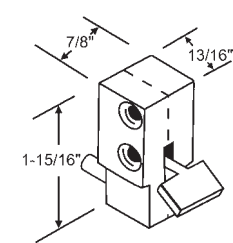

900-8734
Aluminum

Security Lock
for both sliding glass doors and windows

MADE OF UNBREAKABLE LEXAN

Super Holding Power

Installs Without Tools

NOW EVEN EASIER

PATENT PENDING.

- Installs quickly without special tools.
- 3-M special adhesive bonds to glass like a weld
- Provides positive locking protection.
- Secures both sections firmly.
- Unbreakable GE Lexan.
- Crystal-clear transparency.

16-192
Sold in Pairs

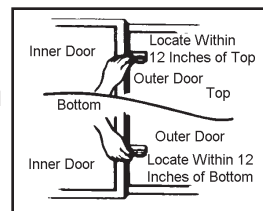

Glass Door Installation:
Position both Security Locks within 12 inches of top and bottom on outer door flush against inner frame.

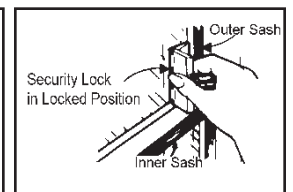

Sash Window Installation:
Position one Security Lock flush in lower corner of top window.

Security Latch

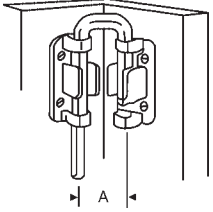

"A" Dimension equals exact center to center measurement

NARROW FOR EXTRA TIGHT CORNERS
Where moldings and jams are narrow and mounting space is limited; 3/4" shackle width.

Part #	Finish	"A"
16-185	Nickel	1-1/8"

- Simple to install
- Very easy to use
- Attractive finishes
- Prevents accidental locking

STANDARD FOR MOST CORNER APPLICATIONS
Where ample mounting space is provided; 1-1/4" shackle width.

Part #	Finish	"A"
16-186	Nickel	1-7/16"

- Can be used on windows too
- Assures snug closure of door
- All mounting hardware included
- Reversible (Works left to right/right to left)
- Latch serves as convenient handle for door

WIDE FOR OFFSET MOUNTING
Where reaches require wider shackle to bridge wide gaps between jams and moldings to wall; 2" shackle width.

Part #	Finish	"A"
16-187	Nickel	2-1/8"

- Makes handy latch for all regular swinging doors
- Mounts anywhere along frame for easy accessibility
- Presently being used by the hospitality industry nationwide
- Sturdily constructed (Handle made from 9/32" steel rod stock)

Key Cylinders

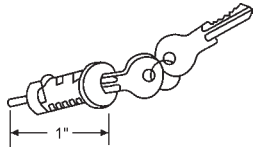

16-100
Key Cylinder Lock

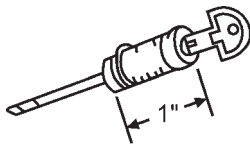

16-126
Key Cylinder

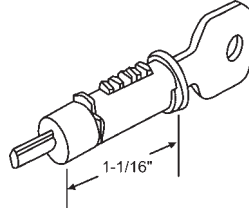

16-189
Key Cylinder

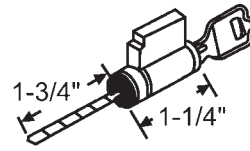

16-133
Key Cylinder Lock

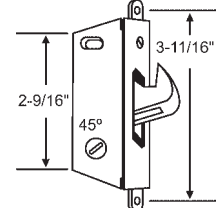

16-170
Square Face

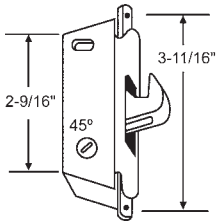

16-171
Round Face

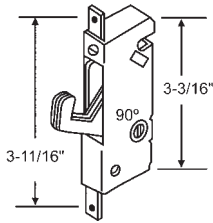

16-173
Square Face

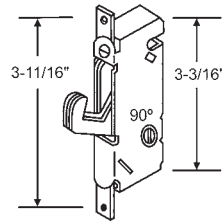

16-174
Round Face

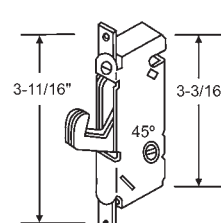

16-175
Round Face

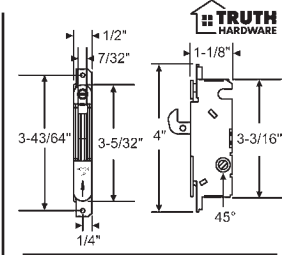

Part #	Description
16-397SS	Stainless Steel
16-397	Clear Chromate

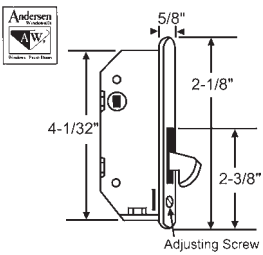

750-1997156

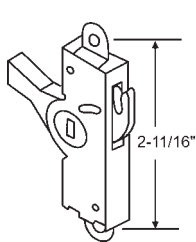

16-142
Used for Surface Mounted
Patio Door Handle

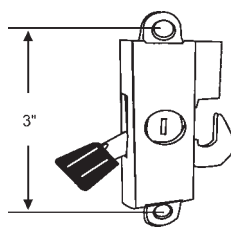

900-7305
Flush Button. Front Surface
Mounted Steel Hook
Peachtree

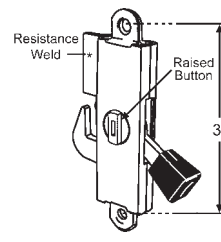

16-673
Raised Button. Front Surface
Mounted Steel Hook
Peachtree

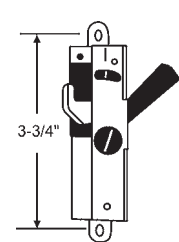

16-176
Used for Surface Mounted
Patio Door Handle

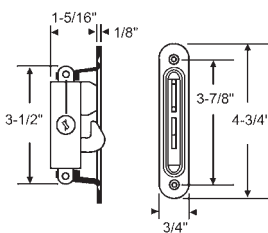

900-9169
Diagonal Hub. Aluminum Finish

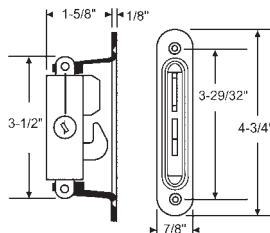

900-18867
Diagonal Hub. Aluminum Finish
Use: 900-14560 for Keeper
Traco

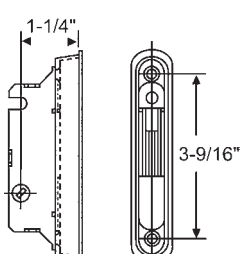

16-443
Mortise Lock and Plate

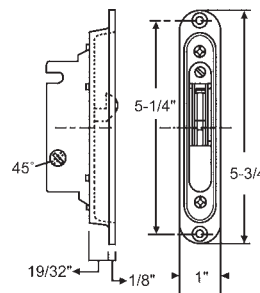

16-441-45
Pocket Trim Plate with 16-175.
Brass Plated

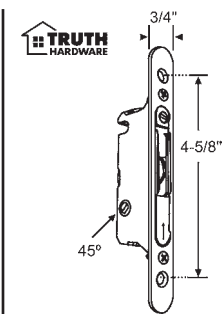

16-363-45
With Faceplate and 16-175

Keepers

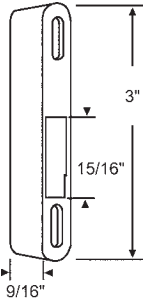

900-8856

Die Cast Keeper for 900-9169

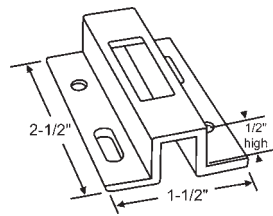

12-299W

White

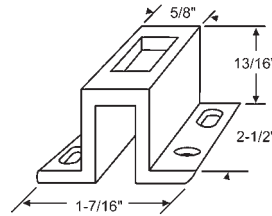

Part #	Finish
12-290W	White
12-290AD	Almond

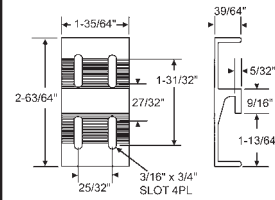

12-286W

White, Four Slot

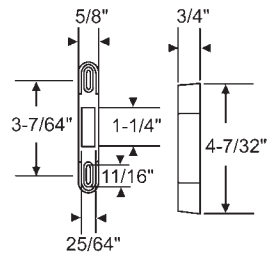

12-294

Yellow Chromate Plated

Latches

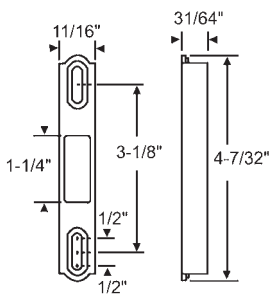

12-271

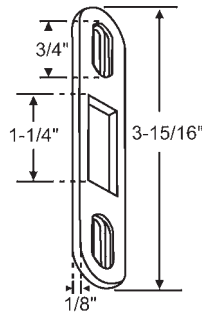

12-272

Flat. For 13-247 & 13-248 Patio Door Handles

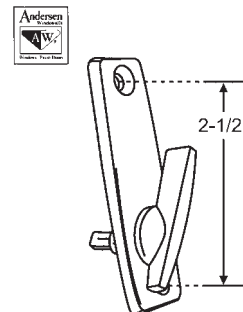

750-1278303

Stone

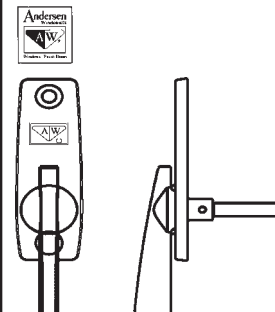

No Longer Available.
Use: 750-2573611

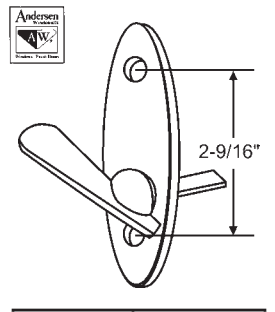

Part #	Finish
750-2573611	Stone
750-2573609	White

Lock Bars

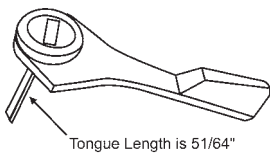

900-11040

Turn Lever with Tailpiece
Black

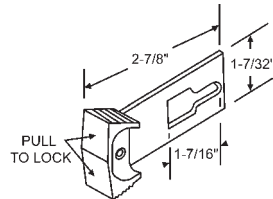

16-188

Lock Bar Without Key
Capitol

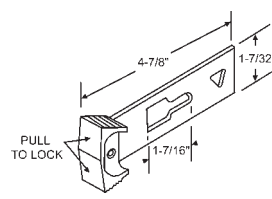

16-230

4-7/8" Lock Bar
Capitol

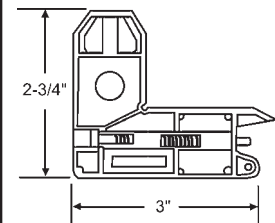

16-116-2

Screen Corner Bracket Assembly
with Screw. 2 per Pack

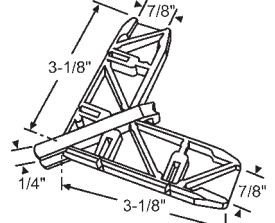

16-361PW

White Nylon Miter Corner
Use on Door 991M-999

Corner Brackets

Repair Tracks

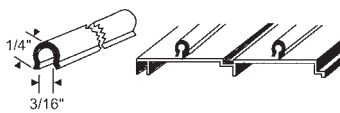

Part #	Length	Minimum Order
16-115	8ft.	(10 8ft. Lengths)
16-115-6	6ft.	(10 6 ft. Lengths)

Replace bent or broken door tracks with stainless steel replacement tracks. Easy to use. Snaps into place over old broken track.

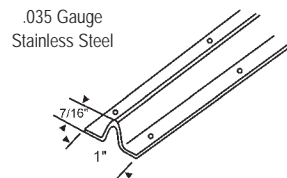

16-251

Replacement Track Cover.
8' Lengths. Sold in multiples of 5 only.
Heavy duty. Recommended for tracks that are too corroded to use 16-115.
Repairman's "first choice" in door replacement track.

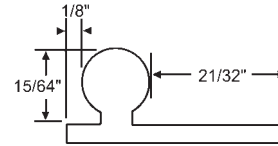

Part #	Length	Finish
16-217-6	6ft.	Anodized
16-217-8	8ft.	Anodized

Glass Door Track Extrusions
1/16" Thick x 15/16" Wide

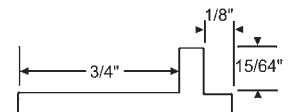

Part #	Length	Finish
16-219-6	6ft.	Anodized
16-219-8	8ft.	Anodized

Screen Door Track Extrusions
1/16" Thick x 15/16" Wide.