

INTRODUCTION TO VINYL JAMBLINERS

DON'T REPLACE - REPAIR your old wood windows with new, thermally-efficient, rattle-free jambliners!

- Vinyl jambliners can reduce air infiltration dramatically and increase the efficiency of wood windows by over 60%!
- They are an excellent option when your customer's wood sash are in good shape but balances, pulleys and weatherstripping are not sufficient.
- We offer a stocking program of tilt and non-tilt jambliners for 1-1/4" and 1-3/8" sash and can provide custom sizes for most window shapes.
- We also provide single and double hung custom made jambliners for 1-3/4" sash. These are used primarily for historical renovations.
- Please refer to our easy-to-use jambliner chart on page 134 to help you determine the jambliner most suited to your customer's needs.
- We also offer a number of options not shown in this catalog. Please contact your account manager for any special requests!

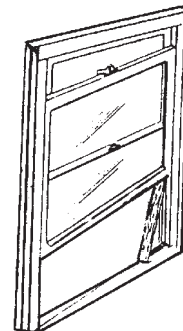

HOW TO MEASURE YOUR EXISTING WINDOW OPENING

WIDTH

To find the width of the sash opening, measure from inside jamb to inside jamb. This measurement should be approximately 4" wider than the glass width.

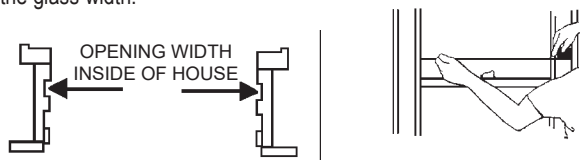

HEIGHT

To find the height of the opening, measure from the header to the sill at the inside edge of the parting bead. This measurement is normally about 6" greater than double the glass height. Also needed is the longest opening height.

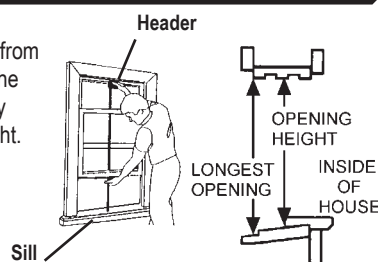

HOW TO INSTALL NON-TILT JAMBLINERS

1. In order to accept our 86A, 86B, 86C, 86D jambliners, you must make a 5/8" wide x 5/8" deep square plough along both sides of the sash.

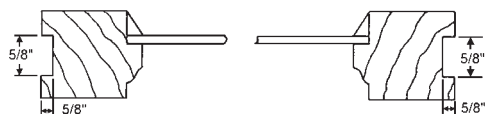

3. Set the lower and upper sash on a chair (per diagram) Note: sash are upside down with the interior (bare wood) towards the chair back.

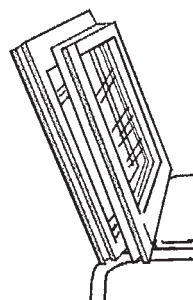

5. Pick up balance with sash so that the interior is facing you. Place the bottom of balance into window frame until it butts outside stop, then ease into position. Raise lower sash, thus driving speed lock into header to secure the balance. Tops of jambliner are slightly aligned for easier installation.

2. If you are replacing sash fitted with ropes or chains, it will be necessary to prepare your opening as follows:

- Cut off ropes or chains.
- Remove sash weight pulleys (four).
- Remove side parting beads; save the head parting bead as it will be reused.

If you are only replacing defective or worn balances, you will need to remove all existing hardware and make room for your new sash/balance system.

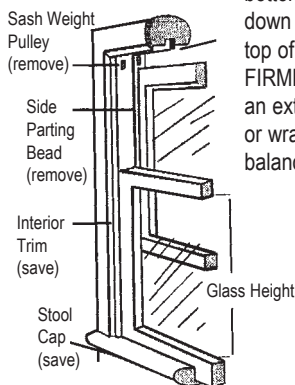

4. Pick up balances with angle cut to top. Place balance with sash platforms resting on bottom of sash. Push sash down about 1-1/2" - 2" below top of balance and HOLD FIRMLY. Note: you may find an extra pair of hands helpful, or wrap tape around sash and balance to assist in handling.

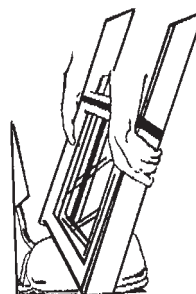

6. Check for proper fit, TEST OPERATION. Then replace stops, head parting bead and remainder of the interior trim.

Account# _____ Salesman _____ PO# _____ Date _____

Jambliner Work Sheet

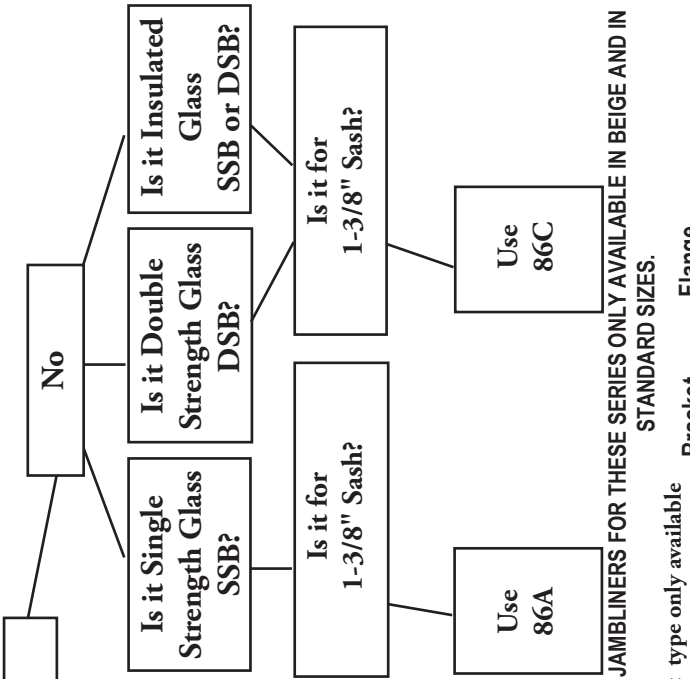

Sash size doesn't matter because parting bead is removed.

JAMBLINERS FOR THESE SERIES ONLY AVAILABLE IN BEIGE AND IN STANDARD SIZES.

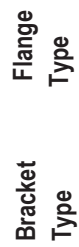

Figure 1

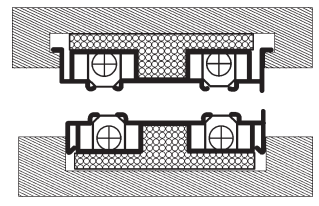

Figure 2

Balances for these Jambliners available in mill only. Jambliners available in white and beige.

Answer Following Questions

Available in custom size. (smallest fraction we can cut is 1/16")

- Circle One: Balance # { 86A, 86B, 86C, 86D, 86E } Available in custom size. (smallest fraction we can cut is 1/16")
- Circle One: Sill Angle - Square Cut (Recommended), 15° (Most Common), 14°, 9°, 7°, 5°, Other _____
- Circle One: Color: Beige or White (86A, 86B, 86C & 86D Available in Beige Only)
- Circle One: Color of Balance: -Mill (Standard), White, Beige (86M, 86MF & 86MS Available in Mill Only)
- Circle One: Type of Glass: - Single Strength - Double Strength - Single Strength Insulated - Double Strength Insulated - Triple Glazed
- Circle One: Bracket Type - (Primarily used in retrofit) Flange Type - (Used in custom mfg.) - See Figure 1.
- Circle One: V plough or Square plough only applies to 86F, 86H, 86G, 86I. - See Figure 2.
- Visible Glass Height of Top Sash _____ Top Sash Weight _____
- Visible Glass Height of Bottom Sash _____ Bottom Sash Weight _____
- Glass Width (Top and Bottom Same) _____
- Overall Length to Longest Point _____ Shortest Point _____

Note: Rule of thumb formula for calculating longest point is two times glass height plus 6-3/8" equals length to the longest point.

Quantity _____ Part # _____ Price _____

I understand this material is custom made to specifications as stated on this form and is non-returnable and non-cancelable.
Signature of authorized buyer _____

TILT JAMBLINERS WITH BLOCK AND TACKLE BALANCES

7000 SERIES / 9000 SERIES

Jambliners with block and tackle balances carry a higher weight range and provide smoother opening and closing compared to spring type balances. To determine which choice best suits your customer's needs, you need to determine:



1. **Bracket Type** - Used primarily in retrofit or flange type -used in custom manufacturing. (Refer to Figure 1).
2. **V Plough or Square Plough** (Refer to Figure 2).
3. **If converting from a non-tilt to a tilt system** - You will need to cut back sash 1-1/2" (Figure 1) and then plough sash as shown (Figure 2).
Our chart on the following page offers standard industry sizes; however we can provide a variety of options. See our jambliner chart on page 134 for any special requests.
4. To purchase ribbed balances separately, see page 51 for 62A series.

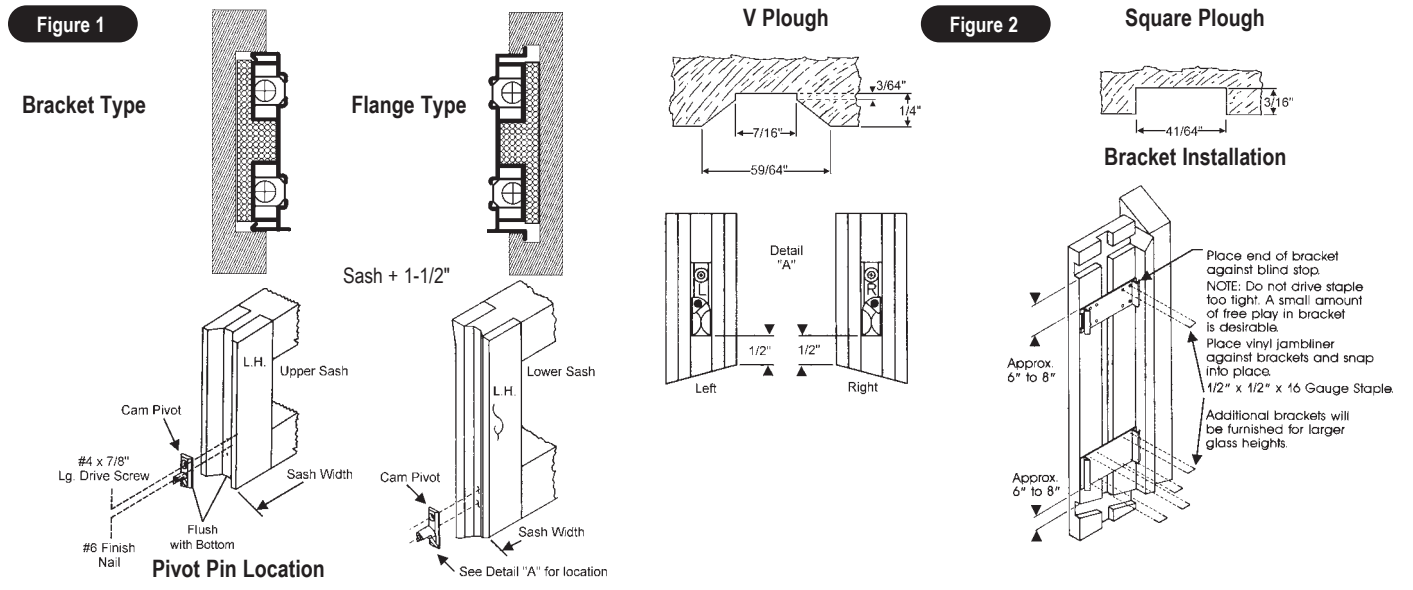
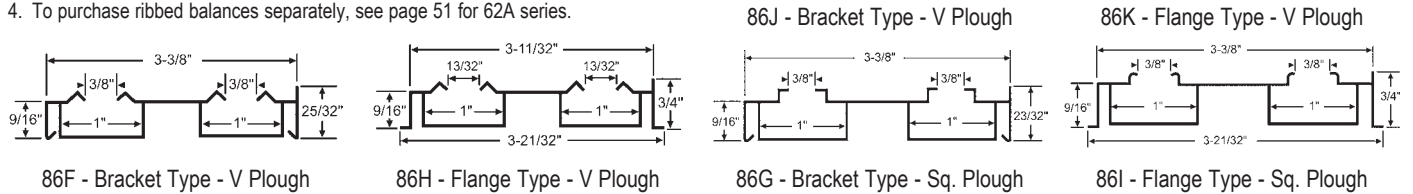

7000/9000 SERIES HARDWARE

CAM PIVOTS

SASH STOP

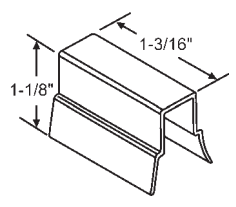
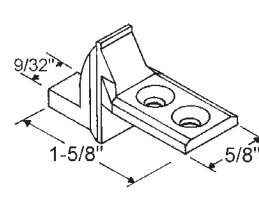
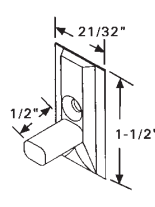
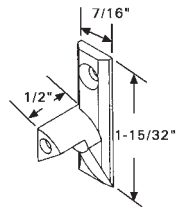
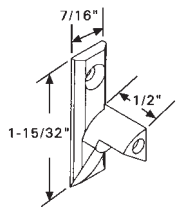

Part #	Description
62-650RH	Zinc
62-649RB	Black Plastic

Part #	Description
62-650LH	Zinc
62-649LW	White Plastic

62-652
Die Cast
Square Plough

62-656
CARADCO

Part #	Color
62-701BG	Beige
62-701	White

BALANCE CLIPS

INSTALLATION BRACKETS

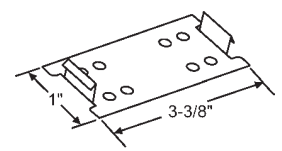
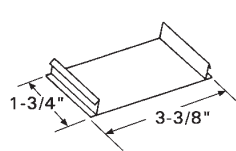
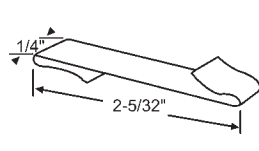
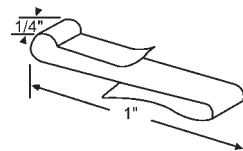

62-517

62-518

86-21
Vinyl Release

86-22
Standard, Metal

TILT JAMBLINERS WITH BLOCK AND TACKLE BALANCES

7000 Series Part # for Standard Jambliner Sets 15° with Standard Lengths.

When ordering any of these Jambliners, identify the number you need and add part number to Jambliner form, sign and fax to our office.

Glass Height	Number Stamped on Balance	Balance Length	Approx. Sash Weight Capacity	86F White Bracket Type V Plough	86H White Flange Type V Plough	86G White Bracket Type Square Plough	86I White Flange Type Square Plough	Length to Longest Point
12"	12 REG	13"	8-11 lbs.	86F-15°-30-3/8	86H-15°-30-3/8	86G-15°-30-3/8	86I-15°-30-3/8	30-3/8"
12"	12HD	13"	12-14 lbs.	86F-15°-30-3/8HD	86H-15°-30-3/8HD	86G-15°-30-3/8HD	86I-15°-30-3/8HD	30-3/8"
14"	14 REG	15"	10-15 lbs.	86F-15°-34-3/8	86H-15°-34-3/8	86G-15°-34-3/8	86I-15°-34-3/8	34-3/8"
14"	14 HD	15"	15-22 lbs.	86F-15°-34-3/8HD	86H-15°-34-3/8HD	86G-15°-34-3/8HD	86I-15°-34-3/8HD	34-3/8"
16"	16 REG	17"	10-17 lbs.	86F-15°-38-3/8	86H-15°-38-3/8	86G-15°-38-3/8	86I-15°-38-3/8	38-3/8"
16"	16HD	17"	17-22 lbs.	86F-15°-38-3/8HD	86H-15°-38-3/8HD	86G-15°-38-3/8HD	86I-15°-38-3/8HD	38-3/8"
18"	18 REG	19"	10-17 lbs.	86F-15°-42-3/8	86H-15°-42-3/8	86G-15°-42-3/8	86I-15°-42-3/8	42-3/8"
18"	18 HD	19"	17-22 lbs.	86F-15°-42-3/8HD	86H-15°-42-3/8HD	86G-15°-42-3/8HD	86I-15°-42-3/8HD	42-3/8"
20"	20 REG	21"	10-17 lbs.	86F-15°-46-3/8	86H-15°-46-3/8	86G-15°-46-3/8	86I-15°-46-3/8	46-3/8"
20"	20 HD	21"	17-20 lbs.	86F-15°-46-3/8HD	86H-15°-46-3/8HD	86G-15°-46-3/8HD	86I-15°-46-3/8HD	46-3/8"
20"	20 TG	21"	20-30 lbs.	86F-15°-46-3/8TG	86H-15°-46-3/8TG	86G-15°-46-3/8TG	86I-15°-46-3/8TG	46-3/8"
22"	22 REG	23"	10-18 lbs.	86F-15°-50-3/8	86H-15°-50-3/8	86G-15°-50-3/8	86I-15°-50-3/8	50-3/8"
22"	22 HD	23"	18-22 lbs.	86F-15°-50-3/8HD	86H-15°-50-3/8HD	86G-15°-50-3/8HD	86I-15°-50-3/8HD	50-3/8"
22"	22 TG	23"	22-30 lbs.	86F-15°-50-3/8TG	86H-15°-50-3/8TG	86G-15°-50-3/8TG	86I-15°-50-3/8TG	50-3/8"
24"	24 REG	25"	10-18 lbs.	86F-15°-54-3/8	86H-15°-54-3/8	86G-15°-54-3/8	86I-15°-54-3/8	54-3/8"
24"	24 HD	25"	18-22 lbs.	86F-15°-54-3/8HD	86H-15°-54-3/8HD	86G-15°-54-3/8HD	86I-15°-54-3/8HD	54-3/8"
24"	24TG	25"	22-30 lbs.	86F-15°-54-3/8TG	86H-15°-54-3/8TG	86G-15°-54-3/8TG	86I-15°-54-3/8TG	54-3/8"
26"	26 REG	27"	10-19 lbs.	86F-15°-58-3/8	86H-15°-58-3/8	86G-15°-58-3/8	86I-15°-58-3/8	58-3/8"
26"	26 HD	27"	19-24 lbs.	86F-15°-58-3/8HD	86H-15°-58-3/8HD	86G-15°-58-3/8HD	86I-15°-58-3/8HD	58-3/8"
26"	26 TG	27"	24-31 lbs.	86F-15°-58-3/8TG	86H-15°-58-3/8TG	86G-15°-58-3/8TG	86I-15°-58-3/8TG	58-3/8"
28"	28 REG	29"	15-22 lbs.	86F-15°-62-3/8	86H-15°-62-3/8	86G-15°-62-3/8	86I-15°-62-3/8	62-3/8"
28"	28 HD	29"	22-28 lbs.	86F-15°-62-3/8HD	86H-15°-62-3/8HD	86G-15°-62-3/8HD	86I-15°-62-3/8HD	62-3/8"
28"	28 TG	29"	28-35 lbs.	86F-15°-62-3/8TG	86H-15°-62-3/8TG	86G-15°-62-3/8TG	86I-15°-62-3/8TG	62-3/8"
30"	30 REG	31"	15-23 lbs.	86F-15°-66-3/8	86H-15°-66-3/8	86G-15°-66-3/8	86I-15°-66-3/8	66-3/8"
30"	30 HD	31"	23-29 lbs.	86F-15°-66-3/8HD	86H-15°-66-3/8HD	86G-15°-66-3/8HD	86I-15°-66-3/8HD	66-3/8"
30"	30 TG	31"	30-36 lbs.	86F-15°-66-3/8TG	86H-15°-66-3/8TG	86G-15°-66-3/8TG	86I-15°-66-3/8TG	66-3/8"
32"	32 REG	33"	15-24 lbs.	86F-15°-70-3/8	86H-15°-70-3/8	86G-15°-70-3/8	86I-15°-70-3/8	70-3/8"
32"	32 HD	33"	24-29 lbs.	86F-15°-70-3/8HD	86H-15°-70-3/8HD	86G-15°-70-3/8HD	86I-15°-70-3/8HD	70-3/8"
32"	32 TG	33"	29-36 lbs.	86F-15°-70-3/8TG	86H-15°-70-3/8TG	86G-15°-70-3/8TG	86I-15°-70-3/8TG	70-3/8"
34"	34 REG	35"	15-24 lbs.	86F-15°-74-3/8	86H-15°-74-3/8	86G-15°-74-3/8	86I-15°-74-3/8	74-3/8"
34"	34 HD	35"	24-29 lbs.	86F-15°-74-3/8HD	86H-15°-74-3/8HD	86G-15°-74-3/8HD	86I-15°-74-3/8HD	74-3/8"
34"	34 TG	35"	29-36 lbs.	86F-15°-74-3/8TG	86H-15°-74-3/8TG	86G-15°-74-3/8TG	86I-15°-74-3/8TG	74-3/8"
36"	36 REG	37"	15-24 lbs.	86F-15°-78-3/8	86H-15°-78-3/8	86G-15°-78-3/8	86I-15°-78-3/8	78-3/8"
36"	36 HD	37"	24-29 lbs.	86F-15°-78-3/8HD	86H-15°-78-3/8HD	86G-15°-78-3/8HD	86I-15°-78-3/8HD	78-3/8"
36"	36TG	37"	29-38 lbs.	86F-15°-78-3/8TG	86H-15°-78-3/8TG	86G-15°-78-3/8TG	86I-15°-78-3/8TG	78-3/8"
38"	38 REG	39"	15-25 lbs.	86F-15°-82-3/8	86H-15°-82-3/8	86G-15°-82-3/8	86I-15°-82-3/8	82-3/8"
38"	38 HD	39"	24-29 lbs.	86F-15°-82-3/8HD	86H-15°-82-3/8HD	86G-15°-82-3/8HD	86I-15°-82-3/8HD	82-3/8"
38"	38 TG	39"	29-38 lbs.	86F-15°-82-3/8TG	86H-15°-82-3/8TG	86G-15°-82-3/8TG	86I-15°-82-3/8TG	82-3/8"
40"	40 REG	41"	15-25 lbs.	86F-15°-86-3/8	86H-15°-86-3/8	86G-15°-86-3/8	86I-15°-86-3/8	86-3/8"
40"	40 HD	41"	25-30 lbs.	86F-15°-86-3/8HD	86H-15°-86-3/8HD	86G-15°-86-3/8HD	86I-15°-86-3/8HD	86-3/8"
40"	40 TG	41"	30-38 lbs.	86F-15°-86-3/8TG	86H-15°-86-3/8TG	86G-15°-86-3/8TG	86I-15°-86-3/8TG	86-3/8"
42"	42 REG	43"	15-25 lbs.	86F-15°-90-3/8	86H-15°-90-3/8	86G-15°-90-3/8	86I-15°-90-3/8	90-3/8"
42"	42 HD	43"	25-30 lbs.	86F-15°-90-3/8HD	86H-15°-90-3/8HD	86G-15°-90-3/8HD	86I-15°-90-3/8HD	90-3/8"
42"	42 TG	43"	30-38 lbs.	86F-15°-90-3/8TG	86H-15°-90-3/8TG	86G-15°-90-3/8TG	86I-15°-90-3/8TG	90-3/8"

To order beige jambliners, add "B" after part number. Example: 86F-15°-30-3/8HDB

Note: For all variations or specials please refer to chart on page 134.

All balances for jambliners are supplied in mill finish. If color balances are required, please fill out form on page 134.

HEAVY DUTY MAGNUM TILT JAMBLINERS FOR 1-3/4" SASH

- The magnum jambliners are the choice for historical restorations.
- Can carry up to 80 lb. sash weights; however, sash over 48" height and 50 lbs. must have limited travel.
- Magnums are offered for both double hung and single hung. Single hung is an excellent choice when top sash is fixed -cost is dramatically reduced.
- Double hung is offered in bracket type or flange type. Single hung is bracket type only.
- Available in white or beige finishes.
- Sets include hardware. Top retainer and can be used to make jambliners non-tilt. Hardware includes (2) RH and (2) LH pivots, (2) sash stops and (2) sash retainers for lower sash. For bracket type installation up to 54", use (4) brackets per set; up to 84", use (6) brackets per set; 84", use (8) brackets per set.

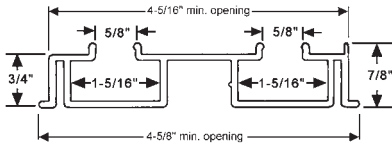

86MF - Flange Type

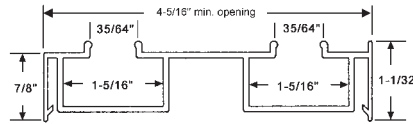

86M - Bracket Type

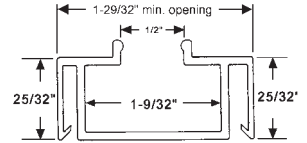

86MS - Bracket Type

***Magnum series is not a stock item and must be custom made. Please fill out information below. These items are non-returnable.**

1. Circle one: Do you want single hung (86 MS) or double hung jambliner?
2. Circle one: If double hung -do you want bracket type (86M) or flange type (86MF)?
3. Circle one: beige or white
4. Circle one: sill angle-square cut (recommended) 15° (most common), 14°, 9°, 7°, 5°, other _____
5. Visible glass height of top sash _____, top sash weight _____
6. Visible glass height of bottom sash _____, bottom sash weight _____
7. Glass width (top and bottom same) _____
8. Overall length to longest point _____ shortest point _____

Example: 86M-Sq-76S45B means double-hung, bracket type jambliner (86M), square cut (Sq.), 76" long, 45 lbs. beige (B).

86M - 86MF - 86MS HARDWARE

Hardware is included with jambliner set. These items can also be purchased separately.

CAM PIVOTS

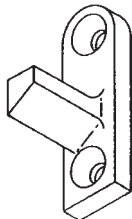

62-651LH

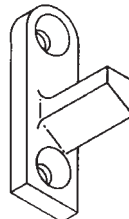

62-651RH

SASH STOP

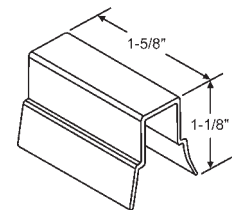

Part #	Color
62-702	White
62-702BG	Beige

SASH RETAINERS

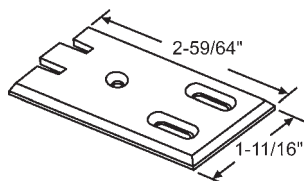

Part #	Color
62-657	White
62-657DBR	Dark Brown

INSTALLATION BRACKETS

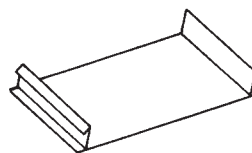

86-16
Single Hung Bracket

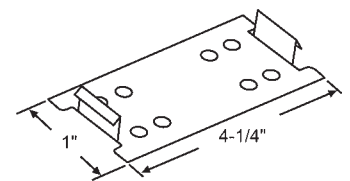

86-9
Double Hung Bracket

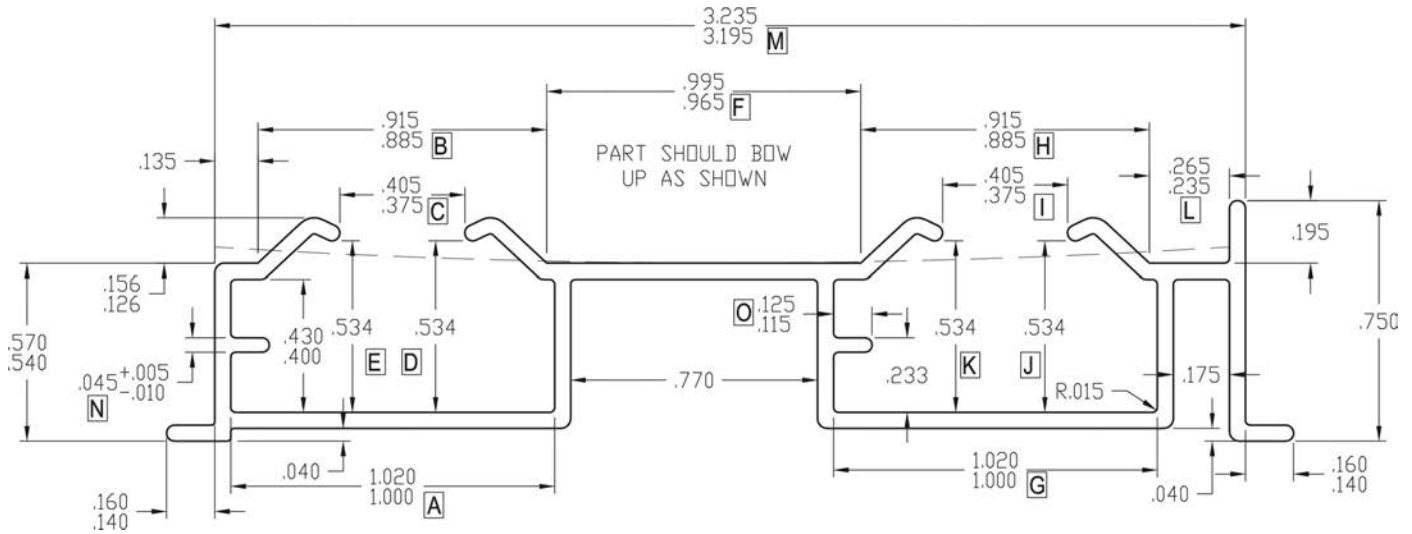

86SEM

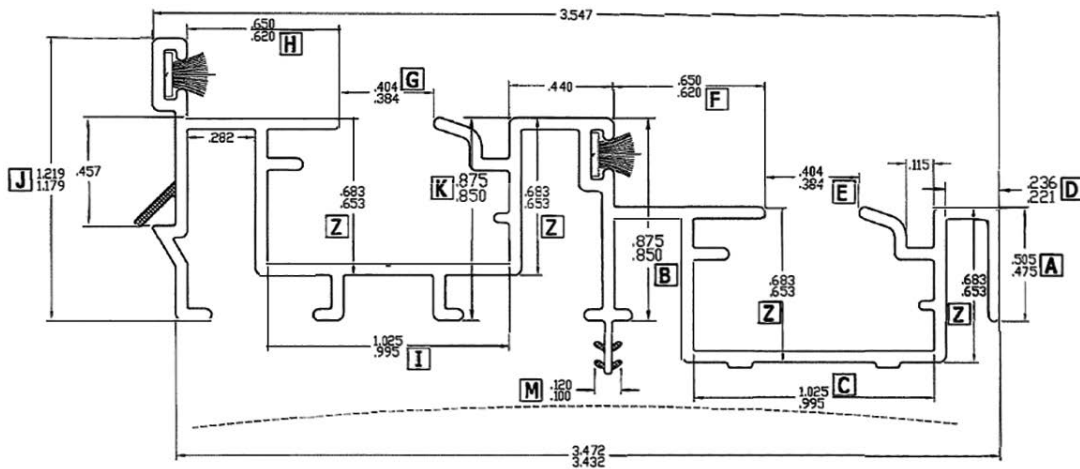

86SEMD

SEMCO series is not a stock item and must be custom made. Please fill out information below.
 These items are non-returnable.

1. Circle one: **86SEM** or **86SEMD**
2. Circle one: **beige** or **white** color of liner
3. Circle one: **beige**, **mill** or **white** color of balance
4. Circle one: sill angle-square cut (recommended) 15° (most common), 14°, 9°, 7°, 5°, other _____
5. Visible glass height of top sash _____, top sash weight _____
6. Visible glass height of bottom sash _____, bottom sash weight _____
7. Glass width (top and bottom same) _____
8. Overall length to longest point _____ shortest point _____

SASH PREPARATION AND INSTRUCTIONS FOR HEAVY DUTY MAGNUM

Sash Preparation for Single and Double Hung

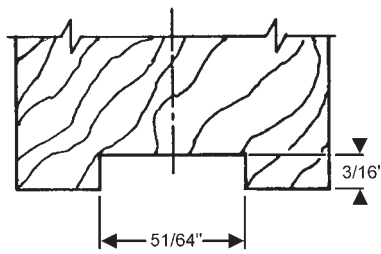

Double Hung Frame Applications and Sash Pre-fit

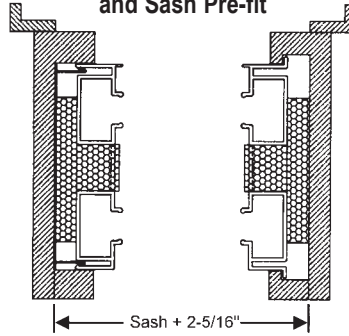

Single Hung Frame Applications and Sash Pre-fit

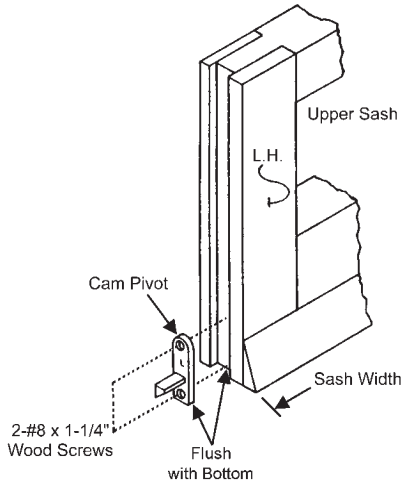
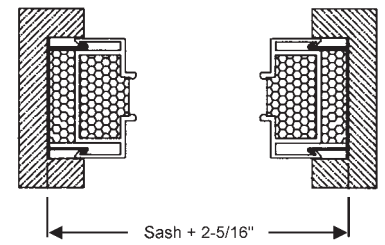

Bracket

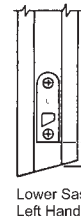

Flange

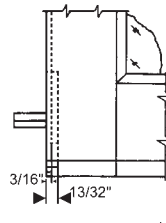

Detail "A"

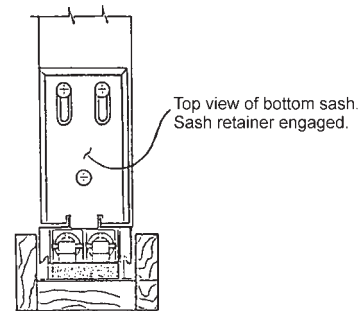
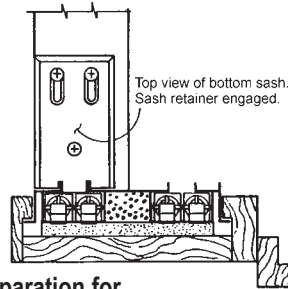
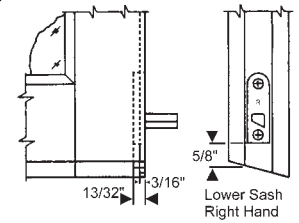

Frame Jamb Preparation for Bracket Application

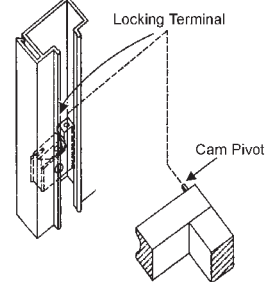
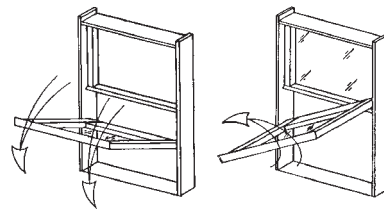
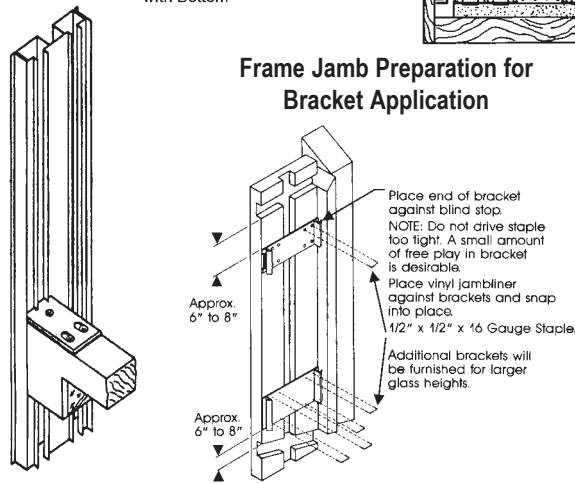

HOW TO INSTALL TILT JAMBLINERS

1. If you are converting a window from a Non-Tilt to a Tilt window or if you are retrofitting a window that previously used pulleys or other balances -you must cut back the sash by 11/16" on each side, reducing the overall sash width by 1-3/8". (See Figure 1.)

3. Apply jambliners to jambs, with bottom touching the sill and flange side touching the blind stop. Press jambliner and drive screws until head is flush with liner. Readjustment of screws may be necessary during STEP 5.

4. Install sash brackets in upper and lower sash as shown below.

5. Insert upper sash into opening in full tilt position. Align pivot pins in the proper channel above carriers. Allow pins to drop into carriers. Pivot sash into place. Repeat for lower sash. Then reinstall the inside trim stops and head parting stop.

Figure 1

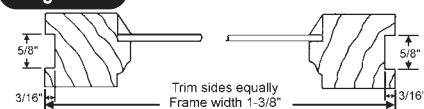

2. Make a 5/8" square x 3/16" deep plough on both sides of sash. (See Figure 1.)

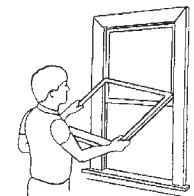
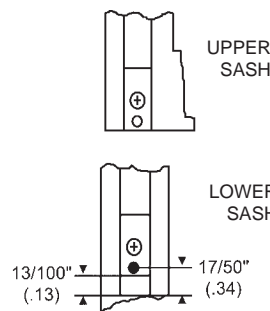
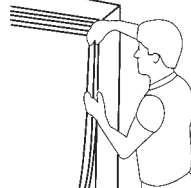

TILT JAMBLINERS

For Tilt Windows with Either Single Strength or Insulated Glass
 86E Series for 1-3/8" or 1-1/4" Sash
 Max Opening Height for 86E Series is 7-6 (90")

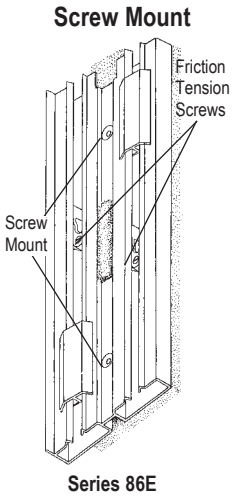

Glass Size	Opening Height	Height	Beige Part #	White Part #	Standard Sash Weight	Heavy Duty Beige Part #	Heavy Duty White Part #	Heavy Duty Sash Weight	Length to Longest Point
12"	2-6	30"	-	86E-30W	11 lbs.	-	86E-30HDW	15 lbs.	30-7/16"
14"	2-10	34"	86E-34	86E-34W	13 lbs.	86E-34HD	86E-34HDW	16 lbs.	34-7/16"
16"	3-2	38"	86E-38	86E-38W	14 lbs.	86E-38HD	86E-38HDW	18 lbs.	38-7/16"
18"	3-6	42"	86E-42	86E-42W	15 lbs.	86E-42HD	86E-42HDW	19 lbs.	42-7/16"
20"	3-10	46"	86E-46	86E-46W	16 lbs.	86E-46HD	86E-46HDW	21 lbs.	46-7/16"
22"	4-2	50"	86E-50	86E-50W	18 lbs.	86E-50HD	86E-50HDW	23 lbs.	50-7/16"
24"	4-6	54"	86E-54	86E-54W	19 lbs.	86E-54HD	86E-54HDW	25 lbs.	54-7/16"
26"	4-10	58"	86E-58	86E-58W	20 lbs.	86E-58HD	86E-58HDW	26 lbs.	58-7/16"
28"	5-2	62"	86E-62	86E-62W	22 lbs.	86E-62HD	86E-62HDW	28 lbs.	62-7/16"
30"	5-6	66"	86E-66	86E-66W	23 lbs.	86E-66HD	86E-66HDW	30 lbs.	66-7/16"
32"	5-10	70"	86E-70	86E-70W	24 lbs.	86E-70HD	86E-70HDW	32 lbs.	70-7/16"
34"	6-2	74"	86E-74	86E-74W	26 lbs.	86E-74HD	86E-74HDW	33 lbs.	74-7/16"

JAMBLINER SASH STOP

Items below included in set.

Full cartons contain 16 sets per box • Each set is individually wrapped with hardware enclosed. Stocked in beige color - White available - Special order • 14° standard sill angle. Please contact your account manager for special sizes or Cottage, Carriage and Oriel windows. Refer to chart on page 134.

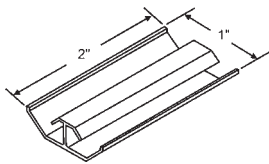

Part #	Color
86E-700BG	Beige
86E-700W	White

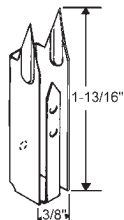

86-701BG
Beige Metal

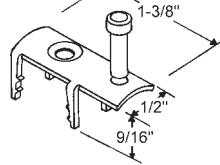

86E-600

PIVOT PINS

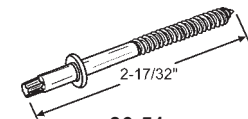

86-51
Torx Head Pivot Pin. #8x18x2
MALTA

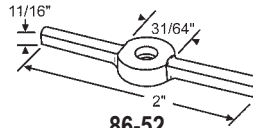

86-52
Propeller Style
MALTA

FRICION SHOE

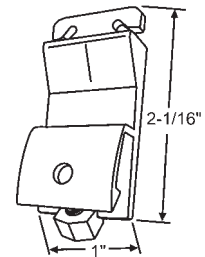

86-511
White
WENCO/JELDWEN

BALANCE SHOE

JAMBLINER ACCESSORIES

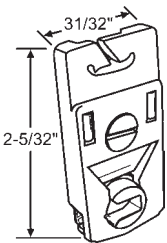

86-66
White With Tan back & Prongs

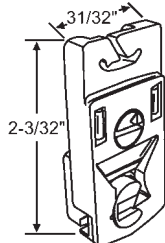

86-67
CAREFREE

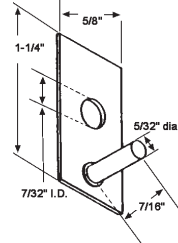

86-10
Pivot Pin

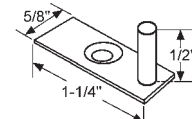

900-14923
Tilt Pin

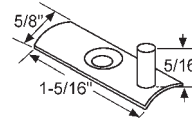

900-15114
Sash Bracket

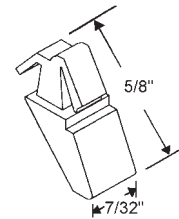

900-21058
Nylon Retainer
NEWELL

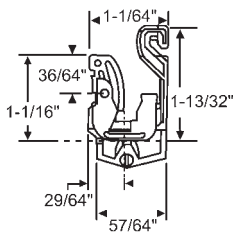

86-64A
No Longer Available.
Use 86-64A-NEW

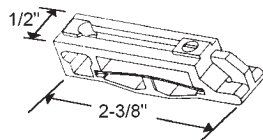

86-24
Heavy Duty Friction Shoe

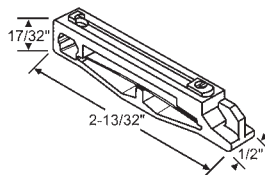

900-21068NS
White Nylon Low Tower Shoe
NEWELL

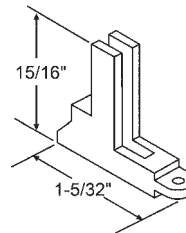

900-5713
Nylon Clutch for Jambliner
MARVIN

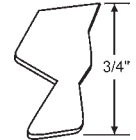

900-5713M
Metal Clutch Actuator for Jambliner
MARVIN

NON-TILT JAMBLINERS

For Single Strength Glass
86A Series for 1-3/8" Sash

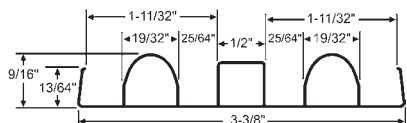
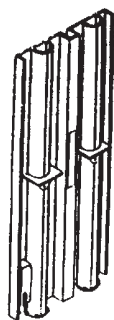

Series 86A

Jambliner Sash Stop

86-701BG
Beige Metal

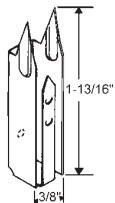

Glass Size	Opening Height	1-3/8" Part #	Maximum Sash Weight	Length to Longest Point
12"	2-6 - 30"	86A-30	7.8 lbs.	30-3/16"
14"	2-10 - 34"	86A-34	8.5 lbs.	34-3/16"
16"	3-2 - 38"	86A-38	9.2 lbs.	38-3/16"
18"	3-6 - 42"	86A-42	9.9 lbs.	42-3/16"
20"	3-10 - 46"	86A-46	10.6 lbs.	46-3/16"
22"	4-2 - 50"	86A-50	11.3 lbs.	50-3/16"
24"	4-6 - 54"	86A-54	12.0 lbs.	54-3/16"
26"	4-10 - 58"	86A-58	12.7 lbs.	58-3/16"
28"	5-2 - 62"	86A-62	13.4 lbs.	62-3/16"
30"	5-6 - 66"	86A-66	14.1 lbs.	66-3/16"
32"	5-10 - 70"	86A-70	14.8 lbs.	70-3/16"
34"	6-2 - 74"	86A-74	15.5 lbs.	74-3/16"
36"	6-6 - 78"	86A-78	15.5 lbs.	78-3/16"

Full cartons contain 20 sets per box.

Only available in beige color • 14° standard sill angle

Please contact your account manager for special sizes or Cottage, Carriage and Oriel Windows. Refer to chart on page 134.

For Insulated or Double Strength Glass
86C Series for 1-3/8" Sash

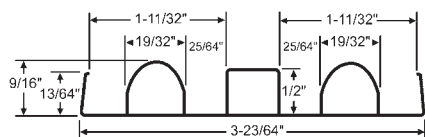
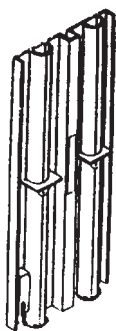

Series 86C

Jambliner Sash Stop

86-701BG
Beige Metal

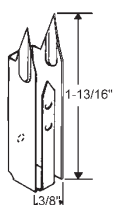

Glass Size	Opening Height	1-3/8" Part #	Maximum Sash Weight	Length to Longest Point
12"	2-6 - 30"	86C-30	11.0 lbs.	30-3/16"
14"	2-10 - 34"	86C-34	12.3 lbs.	34-3/16"
16"	3-2 - 38"	86C-38	13.5 lbs.	38-3/16"
18"	3-6 - 42"	86C-42	14.8 lbs.	42-3/16"
20"	3-10 - 46"	86C-46	16.0 lbs.	46-3/16"
22"	4-2 - 50"	86C-50	17.3 lbs.	50-3/16"
24"	4-6 - 54"	86C-54	18.5 lbs.	54-3/16"
26"	4-10 - 58"	86C-58	19.9 lbs.	58-3/16"
28"	5-2 - 62"	86C-62	21.0 lbs.	62-3/16"
30"	5-6 - 66"	86C-66	22.2 lbs.	66-3/16"
32"	5-10 - 70"	86C-70	23.5 lbs.	70-3/16"
34"	6-2 - 74"	86C-74	24.7 lbs.	74-3/16"
36"	6-6 - 78"	86C-78	26.0 lbs.	78-3/16"

Full cartons contain 20 sets per box.

Only available in beige color • 14° standard sill angle

Please contact your account manager for special sizes or Cottage, Carriage and Oriel Windows. Refer to chart on page 134.

(Brockway Smith)

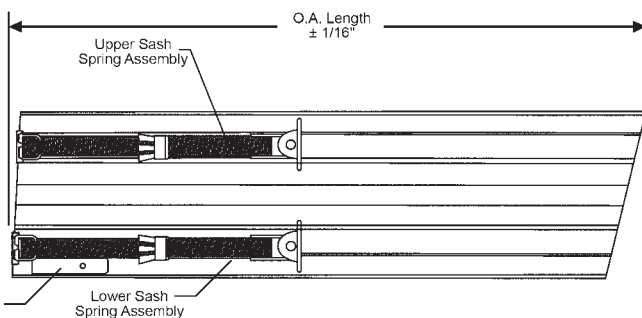
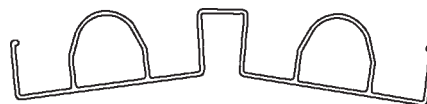
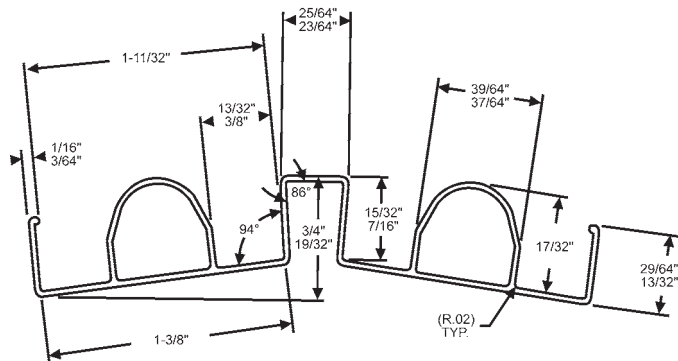

Our Part #	Unit Size	Overall Length ± 1/16"	Color
86BOS-29	2-5	29-23/64"	Beige
86BOS-30	2-6	30-23/64"	Beige
86BOS-31	2-7	31-23/64"	Beige
86BOS-33	3-1	33-23/64"	Beige
86BOS-37	2-5	37-23/64"	Beige
86BOS-41	3-5	41-23/64"	Beige
86BOS-45	3-9	45-23/64"	Beige
86BOS-49	4-1	49-23/64"	Beige
86BOS-16/24	16/24 (Oriel)	45-23/64"	Beige
86BOS-18/26	18/26 (Oriel)	49-23/64"	Beige
86BOS-20/30	20/30 (Oriel)	55-23/64"	Beige
86BOS-24/16	24/16 (Oriel)	45-23/64"	Beige
86BOS-26/18	26/18 (Oriel)	49-23/64"	Beige
86BOS-30/20	30/20 (Oriel)	55-23/64"	Beige

Note: Other sizes and variations are also available. Please contact your account manager for more information